

sparco®

COMPETITION CATALOG
VERSION 4.0



INDEX



DRIVING SUITS
4 - 19



UNDERWEAR & ACCESSORIES
20 - 21



SHOES
22 - 23



GLOVES
24 - 25



HELMETS
26 - 31



COMPETITION SEATS & ACCESSORIES
32 - 41



COMPETITION HARNESSSES
42-43



STEERING WHEELS
44 - 49



FIRE SUPPRESSION
50



SHIFT KNOBS & PEDAL KITS
51



MECHANIC SUITS & ACCESSORIES
52 - 53



ROAD ACCESSORIES
54



JACKETS
55



GEAR BAGS
56 - 57



SPORTSWEAR
58 - 59



CUSTOM SUITS & SEAT DIMENSIONS
60 - 63

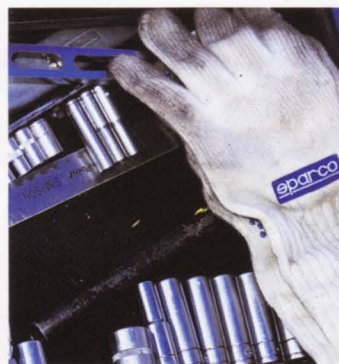

TOP TECHNOLOGY

SPARCO RACEWEAR: THE NUMBER ONE CHOICE FOR RACING TEAMS IN EVERY MAJOR CHAMPIONSHIP AROUND THE WORLD.

WORLD LEADER.

Sparco has become the world leader in the production of fireproof clothing for racing drivers thanks to the quality and style of its designs and the comfort and durability of its products. A SPARCO suit is always smart, even after years of wear and washing. SPARCO is always recognized as a quality product.

SPARCO CLIENTS.

SPARCO products are used by the majority of the world's top drivers and race teams. Drivers such as Hakkinen, Montoya, Villeneuve, Labonte, Gordon and many more rely upon SPARCO to provide the highest levels of comfort and safety, in the most demanding environments.

MEETING THE SAFETY REGULATIONS.

Sparco fireproof clothing conforms to the severe FIA and SFI regulations. Exclusive and technologically advanced materials guarantee that SPARCO driving suits are the lightest and most sophisticated suits available today. Our in-house testing laboratory and R&D department ensures that all SPARCO products are state-of-the-art.

PRODUCTION EQUIPMENT.

In the Sparco workshop more than 50 skilled workers operate the technologically advanced equipment needed to produce a race suit. This sophisticated equipment and almost fanatical attention to detail allows Sparco to guarantee control over the product and to reach a standard of quality that few can hope to emulate. With over 120 embroidery machines and the latest generation of computer technology SPARCO is capable of manufacturing the most sophisticated custom suit designs.

SPARCO' INNOVATIVE X-LIGHT RANGE.

Sparco is proud to present the new X-Light range of products. Designed with exclusive continuity in mind, each of these items has been specifically engineered and tested to be the premier product in its category. In the range you will find the new X-Light suit, X-Light-K Karting suit, X-Light shoes, S-Light seats and the X-Light Harness system. Our teams of designers are constantly at work developing higher levels of safety, style and comfort. Our desire and dedication to being the foremost leader in the motor sports safety field has led to the development of these exceptional products.

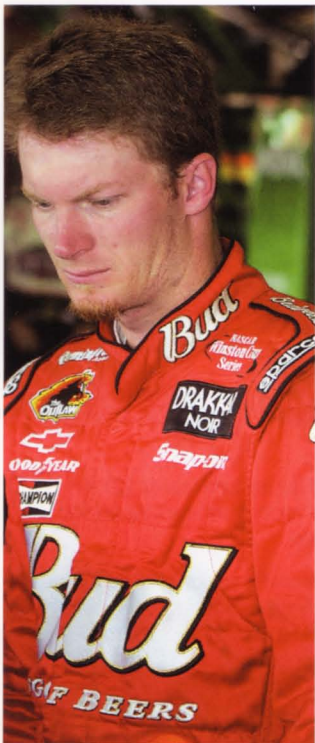

SAFETY...

One of the prime safety concerns in auto racing is protecting drivers and race personnel from the dangers of fire. Incidents in recent years, serve to remind everyone involved that no matter what precautions are taken, the dangers of fire can never be fully eliminated.

Every precaution is taken to maximise protection. The colorful clothing seen in pit lane is the product of extensive research and development.

Material facts: Driver and pit-crew suits are tailored exclusively from lightweight woven Nomex fibers. Embroidered logos are stitched with Nomex thread on the outer layer only, to preserve suit integrity. In a fire cotton, thread can ignite and act as a heat conductor.

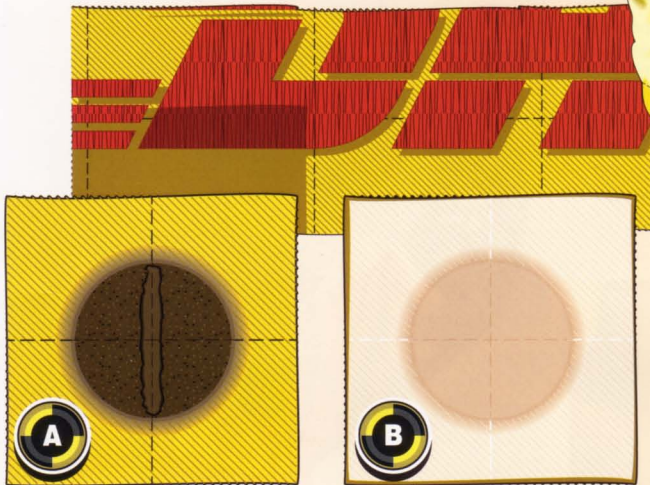

Evidence of heat: In a controlled test, an 800BC liquid propane flame is blasted on to a section of driver's overalls for at least 12 seconds (time specified by FIA regulations). This results in severe burning to the outer layer (A), while the inner layer (B) sustains only moderate signs of thermal heat transfer.

Air dynamics

The box-quoted Nomex stitching on Sparco suits is more than just a nice pattern! Stitching the layers together in this way creates hundreds of small air pockets. Because heat transfer through air is much slower than by direct contact, each pocket dramatically slows the effects of external fire.

A simple test of this theory. Next time you barbecue a steak, check for the pattern of the grill burnt into the meat where there has been direct contact!

Corrugated sandwich weave of Nomex creates millions of tiny air pockets

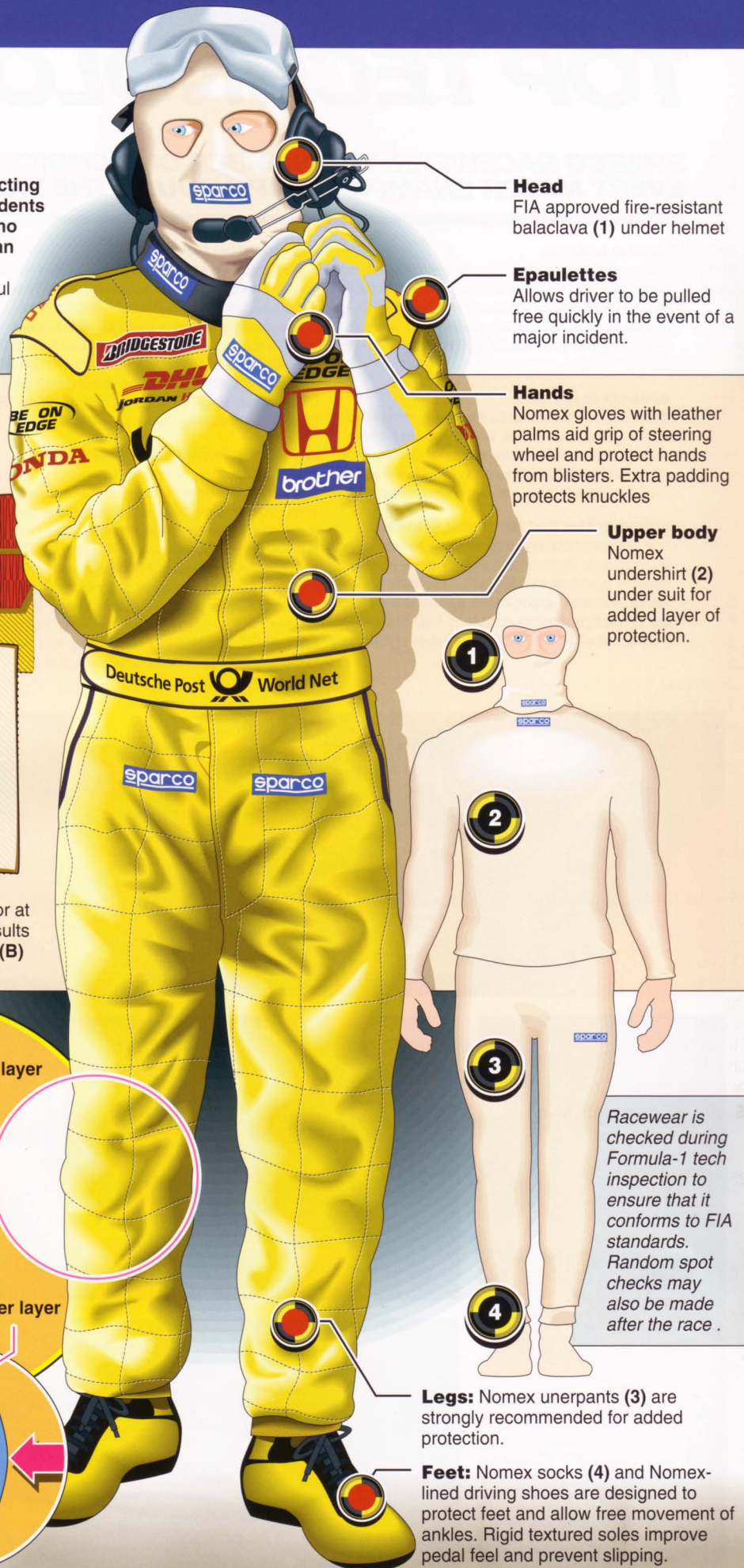
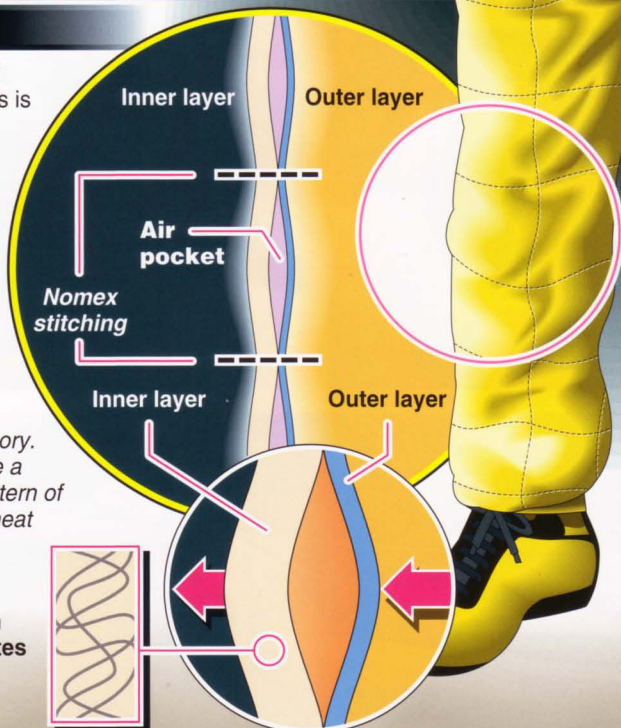

Head
FIA approved fire-resistant balaclava (1) under helmet

Epaulettes
Allows driver to be pulled free quickly in the event of a major incident.

Hands
Nomex gloves with leather palms aid grip of steering wheel and protect hands from blisters. Extra padding protects knuckles

Upper body
Nomex undershirt (2) under suit for added layer of protection.

Racewear is checked during Formula-1 tech inspection to ensure that it conforms to FIA standards. Random spot checks may also be made after the race.

Legs: Nomex unpants (3) are strongly recommended for added protection.

Feet: Nomex socks (4) and Nomex-lined driving shoes are designed to protect feet and allow free movement of ankles. Rigid textured soles improve pedal feel and prevent slipping.

THE BURNING ISSUE.

Introducing...Thermo-man: Du Pont, the manufacturers of Nomex, carry out exhaustive tests on suits whether for F1 drivers or fire-fighters using a life-sized manequin, equipped with computer-linked sensors. The analyzed test data from *Thermo-man* is used to calculate simulated burn patterns

Thermo-man has 120 electronic sensors on his head, torso, arms and legs

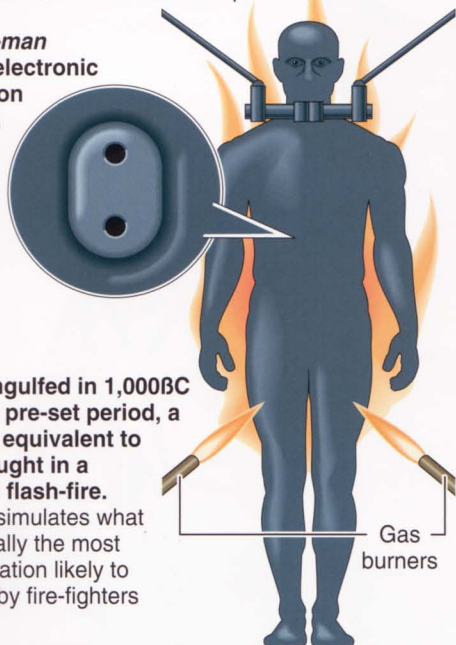

Suit is engulfed in 1,000°C flame for pre-set period, a scenario equivalent to being caught in a chemical flash-fire. This test simulates what is potentially the most lethal situation likely to be faced by fire-fighters

Unharmd 2nd and 3rd degree burns Unharmd

The figures below illustrate average results of comparisons between fire-proof cotton and Nomex body coverings, illustrating the heat restraining properties of F1 drivers clothing. Nomex's stability in intense heat prevents shrinking on to the body, which accelerates heat transfer. The cotton's fire-proofing may also generate toxic fumes when fabric ignites

Fire-proof cotton vest and leggings

Nomex vest and leggings

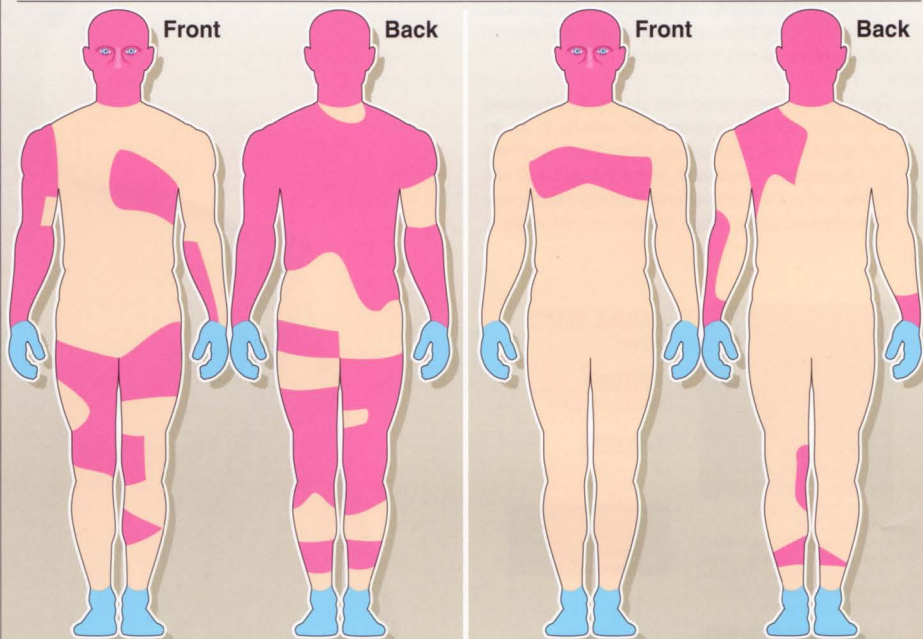

Test time: 4.5 seconds / Burns: 58%

Test time: 8.0 seconds / Burns: 18%

Nomex is the registered trade-mark of DuPont

Fire insurance: Regulations surrounding driver safety are rigid and precise. Before a driver is granted a Super Licence permitting participation in F1 he must satisfy certain criteria. One of these is that in full racewear, with seat-belts properly secured and padding in place, he must be able to evacuate the cockpit and place one foot on the ground within five seconds.

Rules on clothing demand that overalls and underwear should protect a driver from second degree burns for at least twelve seconds.

Scale of protection...

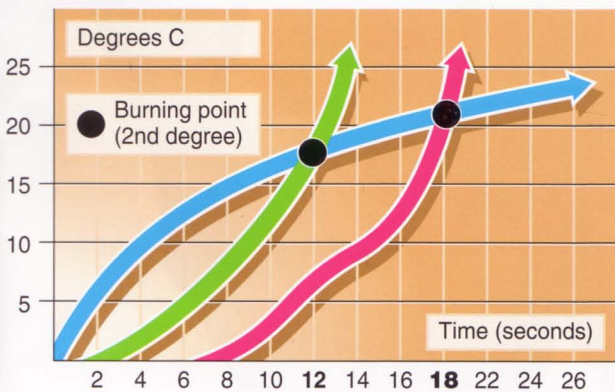

Crew cuts: Pit stop crews are essentially protected by the same clothing as drivers. The key exception is in headwear, where many crews opt for just wearing balaclavas. These have double eye-holes and are formed of a two-layer Nomex front, with a single layer back.

The weak link... Protective goggles now carry a layer of transparent film to reflect heat in the event of fire but, while saving eyes from dirt and splashes, they cannot offer the same high levels of protection as the clothing. In past fires, the goggles have been the weakest point of protection from heat and fire.



Pit crews wear the same lightweight Nomex suits as drivers (around 4.5lbs)

X-LIGHT 300

Once again, setting
THE STANDARD
in safety and technology.

A technological milestone, the X-Light is the lightest most comfortable 3-layer racing suit in the world. This latest achievement in fabric technology has resulted in a suit that is 25% lighter than previously possible, while at the same time surpassing all tests and analysis performed by our safety engineers.

The X-light is constructed with our newly developed multi-layer NOMEX® material that weighs in at an unbelievable 298 grams per sq. meter. That, combined with its superior breathable properties and soft knit inserts at all points of movement, the X-Light sets a new standard in suit safety, design, comfort and performance.



INDEPENDENT MOBILITY

360° articulating NOMEX® shoulder gussets add uncompromised movement plus added airflow to the upper body.



STRETCH PANELS
NOMEX® stretch panel incorporated into the lower back of the suit allows maximum flexibility and range of movement.



SERGED SEAMS
Concealed pockets and special "Serged" seam construction is used for added safety, strength and comfort.

ADULT SIZES

48-64

RATING

SFI 3.2a/5 & FIA

LAYERS

3

CUSTOM SUIT OPTIONS

SEE PAGE 60



HOMOLOGATED



HOMOLOGATED



SHINY GREY

001149L...GRL



RED
001149L...RL

BLUE WITH SHINY GREY
001149X...AGRL

BLUE
001149L...AL



BLACK WITH SHINY GREY
001149X...NGRL

BLACK
001149L...NL

DARK GREY WITH SHINY GREY
001149X...GRGL

TECH 5

The evolution of OVER 25 YEARS of suit making experience.

The most advanced and state-of-the-art racing suit ever produced by Sparco. Designed for the driver that will not accept any compromise when it comes to safety, comfort, and style. The Tech 5 is constructed of a new evolution NOMEX® III inner layer fabric. This revolutionary fabric was developed to decrease the overall weight of your suit, raising the level of comfort drivers experience over the course of a race. By using our newest and most technologically superior inner liner, Sparco has reduced the overall weight of the Tech 5 suit by 30% over our already light weight standard NOMEX® III racing suits.



ULTRA SOFT COLLAR

Ultra Soft NOMEX® inner liner combined with Sparco's exclusive NOMEX® III outer shell provides maximum comfort with high durability.



STRETCH PANELS

NOMEX® stretch panel incorporated into the lower back of the suit allows maximum flexibility and range of movement.



INDEPENDENT MOBILITY

360° articulating NOMEX® shoulder gussets add uncompromised movement plus added airflow to the upper body.



SERGED SEAMS

Concealed pockets and special "Serged" seam construction is used for added safety, strength and comfort.



TECH 5 EPAULETTES

Double stitched for added strength in the event an emergency extraction is required. On the Tech 5 the epaulette has been modified into an "L" shape, which creates less pressure on the back & shoulder when strapped tightly into the seat.

ADULT SIZES

48-64

RATING

SFI 3.2a/5 & FIA

LAYERS

3

CUSTOM SUIT OPTIONS

SEE PAGE 60



HOMOLOGATED



HOMOLOGATED





SHINY WHITE
001145L...BL

SHINY BLACK
001145L...NL

SHINY GREY
001145L...GRL



SHINY BLUE
001145L...AL

SHINY RED
001145L...RL

SHINY YELLOW
001145L...GL

SHINY CELESTE
001145L...CL

PRO-DRIVER

The suit with
INCREASED COMFORT
through freedom of movement.

The incredible comfort of a stretch Nomex fabric is now a technical reality. In the past, racing suits made with stretchable fabric have been extremely heavy, bulky and have lost their shape over time, until now! Finally a suit that incorporates the perfect combination of traditional NOMEX® III with our new Stretch NOMEX® strategically placed throughout the suit.

Our new Pro-Driver suit offers increased flexibility which gives you the extra freedom of movement you desire in a suit that is lightweight and durable.



STRETCH PANELS
NOMEX® stretch panel incorporated into the lower back of the suit allows maximum flexibility and range of movement.



SERGED SEAMS
Concealed pockets and special "Serged" seam construction is used for added safety, strength and comfort.



BOX QUILTING
Developed for our professional suits, box quilting creates hundreds of small pockets of air in the suit. This design aids in heat dissipation and ultimate comfort.

ADULT SIZES

48-64

RATING

SFI/5 & FIA

LAYERS

3

CUSTOM SUIT OPTIONS

SEE PAGE 60



HOMOLOGATED



HOMOLOGATED



GREY / BLACK
0011471..GRN

BLACK / RED
0011471..NR

BLUE / GREY
0011471..AGR

YELLOW / BLUE
0011471..GA

TOP 5

The 2 color version of the **EXTREMELY POPULAR** Prima 5 suit.

Prima translates to "Best" in Italian. The Top 5 is the number one choice for professional drivers in all forms of racing. From Formula One, NASCAR, CART, and IRL, the Top 5 has become the only choice for protection and comfort. Sparco Master Certified Safety Engineers have analyzed hundreds of pages of driver feedback to develop the Top 5 suit. The Top 5 line of suits is a signature of Sparco safety, comfort, functionality and appearance.



ULTRA SOFT COLLAR

Ultra Soft NOMEX® inner liner combined with Sparco's exclusive NOMEX® III outer shell provides maximum comfort with high durability.



SERGED SEAMS

Concealed pockets and special "Serged" seam construction is used for added safety, strength and comfort.



INDEPENDENT MOBILITY

360° articulating NOMEX® shoulder gussets add uncompromised movement plus added airflow to the upper body.



STRETCH PANELS

NOMEX® stretch panel incorporated into the lower back of the suit allows maximum flexibility and range of movement.



SPARCO EPAULETTES

Distinctly designed Sparco epaulettes are double stitched front and rear for added strength in the event an emergency extraction is required.

ADULT SIZES

48-64

RATING

SFI/5 & FIA

LAYERS

3

CUSTOM SUIT OPTIONS

SEE PAGE 60



HOMOLOGATED



HOMOLOGATED



GREY / SHINY WHITE

001115X...GRBL

BLACK / SHINY GREY

001115X...NGRL

RED / SHINY WHITE

001115X...RBL

BLUE / SHINY GREY

001115X...AGRL

SUPER SPEEDWAY

Sparco's LATEST EVOLUTION of the Top 5.

The Super Speedway is a direct result of feedback from some of the top teams in Stock Car and circle track racing. Made with the exact same design and construction as the Top 5 suit, it has the added features of straight pant legs and split collar. All features listed below come standard on the Super Speedway suit. The Super Speedway is available in 3 color combinations and 8 off-the-shelf sizes.



FRONT SPLIT COLLAR

A special inner layer of NOMEX® has been used in the collar to help keep it supported and in the upright position at all times. This special fabric helps to assure you that the collar maintains the proper integrity to protect your neck from heat.



SPARCO EPAULETTES

Distinctly designed Sparco epaulettes are double stitched front and rear for added strength in the event an emergency extraction is required.

ADULT SIZES

48 - 66

RATING

SFI 3.2a/5 & FIA

LAYERS

3 - Shiny White Fabric
2 - Colored Fabric



BOOT CUT CUFF

Due to the overwhelming demand from thousands of circle track racers from around the country we have integrated the straight leg cuff style into this suit.



HOMOLOGATED



INDEPENDENT MOBILITY

360° articulating NOMEX® shoulder gussets add uncompromised movement plus added airflow to the upper body.

BOX QUILTING

Developed for our professional suits, box quilting creates hundreds of small pockets of air in the suit. This design aids in heat dissipation and ultimate comfort.



RED / WHITE
00106X...RBL

BLACK / WHITE
00106X...NBL

BLUE / WHITE
00106X...ABL

BLACK / RED
00106X...NRL

PRO CUP 2

The Pro Cup suit with NEW FEATURES for 2005.

Added for 2005: the 360 degree shoulder gussets. Based upon Sparco's collaboration with the top drivers in NASCAR, the Pro-Cup 2 suit is a light 2-layer box quilted Nomex III suit. This suit is lightweight, very durable, and its straight leg cuff and open style collar, make this the most widely used Sparco suit by stock car and circle track drivers throughout the country.



ADULT SIZES

XS - XXXL

RATING

SFI 3.2A/5

LAYERS

2

FRONT SPLIT COLLAR

A special inner layer of NOMEX® has been used in the collar to help keep it supported and in the upright position at all times. This special fabric helps to assure you that the collar maintains the proper integrity to protect your neck from heat.



BOOT CUT CUFF

Due to the overwhelming demand from thousands of circle track racers from around the country we have integrated the straight leg cuff style into this suit.



INDEPENDENT MOBILITY

360° articulating NOMEX® shoulder gussets add uncompromised movement plus added airflow to the upper body.



BOX QUILTING

Developed for our professional suits, box quilting creates hundreds of small pockets of air in the suit. This design aids in heat dissipation and ultimate comfort.



BLACK / WHITE

00105X2...NB

BLUE / WHITE

00105X2...AB

RED / WHITE

00105X2...RB

SPONSOR 5

The 2 COLOR VERSION of the Sparco 5.

The classic Sparco suit design which revolutionized the racing world when it was introduced in Formula One. The Sponsor 5 comes in Blue and White with a Red stripe. The Sponsor 5 suit is perfect for the racer who seeks style and comfort. Due to the two-layer construction of the Sponsor 5 the overall weight of the suit is dramatically reduced while still exceeding FIA and SFI 3.2a/5 standards.



INSULATED COLLAR
A special inner layer of NOMEX® has been used in the collar to help keep it supported and in the upright position at all times. This special fabric helps to assure you that the collar maintains the proper integrity to protect your neck from heat.



**SPARCO
EPAULETTES**
Distinctly designed Sparco epaulettes are double stitched front and rear for added strength in the event an emergency extraction is required.

ADULT SIZES

48 - 64

RATING

SFI/5 & FIA

LAYERS

3 - Shiny White Fabric
2 - Colored Fabric

**CUSTOM SUIT
OPTIONS**
SEE PAGE 60

COLLAPSIBLE STRETCH SYSTEM

An internal elastic band has been surrounded by an outer layer of NOMEX® fabric on the interior and back portion of this suit, allowing the suit to stretch and contour to your own unique body type. When fully expanded it can add up to 3 inches of mobility and freedom.



BOX QUILTING
Developed for our professional suits, box quilting creates hundreds of small pockets of air in the suit. This design aids in heat dissipation and ultimate comfort.



HOMOLOGATED



HOMOLOGATED



SHINY WHITE / BLACK
001125S...NBL



SHINY WHITE / BLUE
001125S...ABL

SPARCO 5

Set THE STANDARD in suit design.

The Sparco 5 has been the best selling suit over the past 10 years. It's two layer construction offers a light-weight, comfortable suit while still meeting strict FIA and SFI 3.2a/5 safety regulations. The suit meets these regulations due to the exclusive Sparco techniques used for the knitted lining, which offers constant and optimal thermal protection properties.



INSULATED COLLAR
A special inner layer of NOMEX® has been used in the collar to help keep it supported and in the upright position at all times. This special fabric helps to assure you that the collar maintains the proper integrity to protect your neck from heat.



SPARCO EPAULETTES
Distinctly designed Sparco epaulettes are double stitched front and rear for added strength in the event an emergency extraction is required.

ADULT SIZES

48 - 66

RATING

SFI/5 & FIA

LAYERS

3 - Shiny White Fabric
2 - Colored Fabric

COLLAPSIBLE STRETCH SYSTEM

An internal elastic band has been surrounded by an outer layer of NOMEX® fabric on the interior and back portion of this suit, allowing the suit to stretch and contour to your own unique body type. When fully expanded it can add up to 3 inches of mobility and freedom.

CUSTOM SUIT OPTIONS

SEE PAGE 60



HOMOLOGATED



HOMOLOGATED

BOX QUILTING

Developed for our professional suits, box quilting creates hundreds of small pockets of air in the suit. This design aids in heat dissipation and ultimate comfort.



RED
001125...R

BLUE
001125...A

BLACK
001125...N

SHINY WHITE
001125...BL

FASHION 5

The 2 COLOR VERSION of the Sprint 5.

Sparco's entry level racing suit meets the same safety requirements as our top of the line suits, but available to racers with a moderate budget. The Fashion suit comes in a two color combination, setting it aside from it's single color counterpart, the Sprint 5.



INSULATED COLLAR
A special inner layer of NOMEX® has been used in the collar to help keep it supported and in the upright position at all times. This special fabric helps to assure you that the collar maintains the proper integrity to protect your neck from heat.



INDEPENDENT MOBILITY
360° articulating NOMEX® shoulder gussets add uncompromised movement plus added airflow to the upper body.

ADULT SIZES

48-64

RATING

SFI/5 & FIA

LAYERS

2



HOMOLOGATED



HOMOLOGATED



BLACK / RED
001085Y...NR

BLUE / CELESTE BLUE
001085Y...AC

BLUE / YELLOW
001085Y...AG

BLACK / PEARL
001085Y...NP

SPRINT 5

Combining
SAFETY, STYLE & COMFORT
at an affordable price.

The most economical Sparco FIA and SFI 3.2a/5 rated suit. The comfortable and innovative design of the knit NOMEX® shoulder gussets, give it an aggressive, modern look. The Sprint, has become a popular choice among racers worldwide.

ADULT SIZES

48-64

RATING

SFI/5 & FIA

LAYERS

2



HOMOLOGATED



HOMOLOGATED



WHITE
001085...B

BLUE
001085...A

BLACK
001085...N

RED
001085...R

REPLICA

The combination of
STYLE & AFFORDABILITY
in a driving suit.

Based on our popular Sprint 5 suit, the Replica suit combines the value and features of the Sprint 5 with the added style of the widely popular shiny fabric.

ADULT SIZES

48-64

RATING

SFI/5 & FIA

LAYERS

2



HOMOLOGATED



HOMOLOGATED



PEARL
001085...P

ONE PLUS

Quality, comfort and
SUPERIOR DESIGN
in one suit.

The new One Plus is an affordable single layer NOMEX® suit that shares many of the same styling features as our top of the line race suits. The One Plus is the perfect solution for the driver or crew that requires the SFI 3.2A/1 rating but still desires the quality, comfort and superior design found in every Sparco suit.



SERGED SEAMS
Concealed pockets and special "Serged" seam construction is used for added safety, strength and comfort.

ADULT SIZES

SM - XXL

RATING

SFI 3.2a/1

LAYERS

1



BOX STITCHING
Styled after our multi-layered suits, box stitching creates a professional look.



BOOT CUT CUFF
Due to the overwhelming demand, the boot cut cuff style with concealed knit cuffs is now integrated into this suit.



INDEPENDENT MOBILITY
360° articulating NOMEX® shoulder gussets add uncompromised movement plus added airflow to the upper body.



BLUE / GREY
001050PAGR...



BLACK / GREY
001050PNGR...

ONE

The suit featuring
SINGLE-LAYER NOMEX®
 at an affordable price.

The new "One" is our most economically priced single layer NOMEX® suit. The "One" is an excellent choice for the driver or team that is required to meet the SFI 3.2A/1 rating when on the track or in the pits. Keep your entire team safe and looking professional with this new affordable "One" suit offered by Sparco.



BOX STITCHING
 Styled after our multi-layered suits, box stitching creates a professional look.



BOOT CUT CUFF
 Due to the overwhelming demand, the boot cut cuff style with concealed knit cuffs is now integrated into this suit.

ADULT SIZES

SM - XXL

RATING

SFI 3.2a/1

LAYERS

1



RED
 001051RS...

BLACK
 001051NR...

BLUE
 001051AZ...

CARMYTH

CARMYTH FABRIC: A GROUND-BREAKING NEW TECHNICAL MATERIAL.

Newly developed in the Sparco laboratories the Carmyth fabric is a mix of meta-aramydic and para-aramydic fibers. Carmyth fabric has a higher flame resistance than any previous material used in the manufacturing of race wear. Test results have been extraordinary: Carmyth has surpassed FIA standards with a fabric weight lighter than all other previous materials. Carmyth is also extremely soft and has an excellent wicking property which keeps you safe, cool and comfortable under the most severe conditions.

NEW

OPEN EYE
EXTRA FLAT SEAMS
001482...



DUAL EYE
EXTRA FLAT SEAMS
001492...



LONG SLEEVE
S - XL
001762M...



UNDERPANTS
S - XL
001762P...

SOFT-TOUCH NOMEX®

AVAILABLE COLORS

NEW

OPEN EYE
EXTRA FLAT SEAMS
001481...



DUAL EYE
EXTRA FLAT SEAMS
001491...



SHORT SLEEVE
S - XL
001791TS...

LONG SLEEVE
S - XL
001761M...



LONG SOCKS
S - XL
001520BI...

SHORT SOCKS
S - XL
001510BI...

UNDERPANTS
S - XL
001761PBI...

NOMEX® BALACLAVAS



OPEN EYE
FIA
00140B



DUAL EYE
FIA
00141B



OPEN EYE
SINGLE LAYER
00144B



DUAL EYE
SINGLE LAYER
00145B



OPEN EYE
FIA / FLAT SEAMS
00148B



DUAL EYE
FIA / FLAT SEAM
00149B

NOMEX® UNDERWEAR



NOMEX®. Available in white only. S - XL

T-SHIRT
00174M

BOXER
00174P

LONGSLEEVE UNDERSHIRT
00176M

Sparco's NOMEX® underwear is the lightest and most comfortable found in the racing industry. When seconds count wearing NOMEX® underwear gives you added protection that can make that critical difference. Our NOMEX® underwear can also keep you feeling cooler on hot days by wicking perspiration from the body. This will also keep your suit clean and comfortable by preventing the suit from becoming perspiration soaked. Once you try our NOMEX® underwear you will never again put your suit on without it.



NOMEX®. Available in white only.
Sizes: 38/39 - 40/41 - 42/43 - 44/45
LONG **SHORT**
00152... 00151...



NOMEX®. Available in white only. S-XL
LONG UNDERPANTS
00176P...

NECK SUPPORT

Designed with an anatomical rear support. It has been homologated after a very detailed examination by a team of 8 physicians who evaluated its reliability in terms of protection from very strong impacts. A padding with different density degrees has been used. Thus, the neck support will be harder where it meets the base of the helmet and softer on the chin and in the rear areas, in order to reduce the burden of the helmet weight. In red, blue or black NOMEX® fireproof fabric.

BLACK **RED** **BLUE**
00163N 00163R 00163A



KNEE & ELBOW PADS



NOMEX®. Available in red or blue.

KNEE PADS
00156

ELBOW PADS
00157

To protect the neck from injury caused by the centrifugal force when cornering in cars and karts with high lateral grip. In red, blue or black NOMEX® fireproof fabric. Molded and completely wraparound.



BLACK **RED** **BLUE**
00160N 00160R 00160A

SUPER SPEEDWAY

Not simply shoes, but the result of a long research and development process at the highest levels. In these racing shoes Sparco has synthesized 25 years of experience in racing from Karting to Formula one. The upper is made with a combination of suede and carbon look leather. The ultra high grip multi density sole incorporates our new Carmyth technology which maximizes safety, comfort and control.

ADULT SIZES

39 - 45



RED

001232..R

GREY

001232..GR

BLUE

001232..A

X-LIGHT HIGH

The X-Light boot has a new anatomical design that maximizes ease of movement and comfort. Newly incorporated NOMEX® panels allow us to keep weight to a minimum. A supremely technical sole with differentiating materials maximize driving sensitivity while maintaining the unmistakable style and quality of Sparco racing shoes.

ADULT SIZES

39 - 45



BLACK

00120X2..N

BLUE

00120X2..A

RED

00120X2..R

X-LIGHT MID

A mid top version of the X-Light High for drivers seeking greater ankle mobility.

ADULT SIZES

39 - 45



BLACK

00121X2..N

BLUE

00121X2..A

RED

00121X2..R

TOP 2

SPEEDWAY

Designed with safety and durability in mind, the Rally is a mid top shoe made with a fire resistant NOMEX® liner and a suede outer material. The slightly heavier sole not only increases the durability, but also makes it a more comfortable walking shoe for leisure wear.

ADULT SIZES

36 - 48



Color	BLUE	RED	YELLOW	GREY	BLACK
Sizes	36-48	36-47	39-44	41-46	36-48
	001242...A	001242...R	001242...G	001242...GR	001242...N

This new mid top professional style boot uses the finest suede and leather available. Designed for maximum comfort and support the Speedway features Sparco's exclusive lightweight ultra rigid anti-slip sole. Added reinforcing provides excellent lateral support and extra protection.

ADULT SIZES

37 - 46

Color **WHITE**
Material **LEATHER**
00122SP...BI

Color **GREY**
Material **SUEDE**
00122S...GR



Color	BLUE	BLACK	RED	BLUE	RED
Material	SUEDE	SUEDE	SUEDE	LEATHER	LEATHER
	00122S...A	00122S...N	00122S...R	00122SP...A	00122SP...R

RALLY

VINTAGE

Designed with safety and durability in mind, the Rally is a mid top shoe made with a fire resistant NOMEX® liner and a suede outer material. The slightly heavier sole not only increases the durability, but also makes it a more comfortable walking shoe for leisure wear.

ADULT SIZES

40 - 46



BLACK	BLUE
00128RA...NR	00128RA...AZ

Sparco's new leather retro style race shoe. Features all the safety and technical aspects of our top of the line shoes, with a stylish vintage look.

ADULT SIZES

40 - 45



BLACK	BROWN
00123V...N	00123V...TM

BLIZZARD

X-PRO

After collecting the suggestions, demands and requirements of professional drivers worldwide, we has engineered this new state of the art driving glove. The Blizzard meets the new FIA standard by incorporating a complete NOMEX® palm with strategically placed leather in critical areas.

ADULT SIZES
8 - 12



PREFORMED SHAPE



PADDED KNUCKLES



ELASTIC WRIST



YELLOW
00132X...GI

BLUE
00132X...AZ

RED
00132X...RS

Preformed shape and externally stitched seams offer the maximum driving sensitivity and superior comfort. Newly developed "Lizard Skin" is a surface treated leather material that will provide unmatched comfort, grip and durability.

ADULT SIZES

8 - 12



LONG GAUNTLET



EXTERNAL STITCHING



PREFORMED SHAPE



VELCRO® WRIST



BLUE
00131X...A

RED
00131X...R

BLACK
00131X...N

FAST TECH

WAVE

The Fast Tech has been the choice of drivers at all levels of auto racing over the past several years. The suede padded palm and external stitching has made this Sparco's best selling glove ever.

ADULT SIZES
8 - 12



LONG GAUNTLET



EXTERNAL STITCHING



SUEDE PADDED



VELCRO® WRIST



RED
00130...R

BLUE
00130...A

BLACK
00130...N

YELLOW
00130...G

GREY
00130...GR

For the driver that is in search of a glove that is not only extremely comfortable but is also very durable. The Wave features added knuckle protection and NOMEX® and leather palm that meets the latest FIA standards.

ADULT SIZES

8 - 12



MEDIUM GAUNTLET



PADDLED KNUCKLES



ELASTIC WRIST



YELLOW
00137X...G

GREY
00137X...GR

BLACK
00137X...NR

RED
00137X...RS

PROFI 2

This glove consists of the same basic construction as the Grand Prix. The Profi 2 does not have the knuckle protection of the Grand Prix glove. This glove is also extremely durable and provides great comfort, and functionality at an affordable price.

ADULT SIZES

7-13



RED 001392...R
YELLOW 001392...G
BLACK 001392...N
BLUE 001392...A

PREMIUM

Derived from the very successful Profi. The Premium offers great features for a very affordable price.



BLACK 00136...N
RED 00136...R
BLUE 00136...A

HURRICANE SPEED

An entry level NOMEX® glove featuring a NOMEX® and suede palm at an economical price

ADULT SIZES

8 - 12



BLUE 00136X...A
BLACK 00136X...N
RED 00136X...R

This glove is great for those drivers just starting off in NOMEX® racewear. It features a suede palm and a VELCRO® wrist adjuster. The Speed is a great quality for the price, without all of the bells and whistles offered by the other high performance Sparco gloves.

ADULT SIZES

XS - XL



BLACK 00134S...N
RED 00134S...R
BLUE 00134S...A

SPARCO HELMETS



Sparco products have been keeping racers safe for 25 years.

Sparco engineers have now developed a helmet that continues that long-standing tradition of excellence. After studying the needs of the racer and through extensive scientific research and testing, the new WTT line of helmets was created. In order to define a standard combining aerodynamic efficiency with the highest level of safety, we turned to the Fiat Research Center in Torino, Italy, one of the most advanced automotive research centers in the world. Their many years of aerodynamic testing experience include automotive components, racing cars, trains and much more.

The two main objectives of the research were:

1. To examine the aerodynamic characteristics of the new helmet, including the performance of spoilers and stabilizers that can be added to the helmet shell; and
2. To verify the effectiveness of the aeration system, by identifying the optimum position of both the air inlets and outlets on the shell.

The Fiat Research Center has developed extremely sophisticated code for simulating airflow. The advanced aerodynamic properties of these new helmets are the result of exhaustive testing performed at Fiat's Wind Tunnel Facility, hence the name WTT (wind tunnel tested). Literally hundreds of hours of testing have yielded a design that is virtually invisible to the wind.



Polystyrene Inner Lining



Wide & Narrow Eye Ports



Reversible Air Ducts



Wind Tunnel Tested



Pre-Formed Inner Lining



Micro-Adjustable Pivot

helmets
SPARCO



After determining the optimum design of the shell, we then moved to our new state of the art composite facility for the construction of the helmets. The shell is constructed of 100% fiberglass which was found to yield the best combination of strength and weight. A sophisticated vacuum form resin strengthening process in conjunction with a proprietary Robotic Resin Thickness Control ensures maximum material integrity with a zero tolerance value between shells. Each shell is then electronically measured to verify its accuracy.

The shell openings are then cut using a precision Robotic Hydro-Jet Process. This advanced technical process ensures precise positioning of the visors and ventilation openings as well as perfect edges on all gasket sealing surfaces. The shell is then finished with 3 layers of fire resistant paint, which includes a primer coat, color coat, and clear coat.

Safety, comfort and durability were main objectives for the internal construction. The Polystyrene inner liner works in conjunction with the outer shell to dissipate the energy created during an impact by absorbing and distributing the shock energy over the largest possible surface. The polystyrene foam inner liner is precisely matched to the shape of the shell. This tight tolerance helps maximize impact management.

Fit and comfort are crucial elements in the function and overall performance of a helmet. Extensive testing on the open cell comfort foam has yielded data allowing us to use the optimum density foam in each area of the helmet. This ensures a proper fitting helmet with maximum comfort. A unique channeling system incorporated into the polystyrene liner allows air to circulate more efficiently throughout the helmet, further enhancing the driver's comfort. The interior is then completely covered in a specially knitted 100% ultra soft NOMEX®. We have also designed the inner lining of the F1 model to be completely and easily removed, making cleaning and servicing much easier. Special attention has also been paid to all other hardware and accessories. The chinstrap is a fire resistant aramid fiber with quick pull safety tag. All air ducts, spoilers and stabilizers are as light as possible while still retaining superior strength. Even the visor hardware is made from CNC machined aluminum.

All of this adds up to the finest helmets offered on the market today. No other helmets could have carried the name Sparco.

F1 CARBON

WIND TUNNEL TESTED



HANS EQUIPPED

Specifically engineered platform with pre-installed HANS hardware.



SNELL SA 2000 CERTIFIED



APPROVED



Adult Sizes:

XS (53cm - 54cm)	00357Z1XS
S (55cm - 56cm)	00357Z2S
M (57cm - 58cm)	00357Z3M
L (59cm - 60cm)	00357Z4L
XL (61cm - 62cm)	00357Z5XL

MEETING THE NEW FORMULA 1 STANDARD.

Our composite and helmets engineers have developed this helmet to meet the new #8860 FIA homologation. The F1 Carbon is the outcome of state of the art technology. Born and tested in the wind tunnel, this 100% Carbon Fiber full face helmet has been engineered to give drivers unequalled safety and performance.



SHELL PROPERTIES & TECHNOLOGIES

- > 100% Carbon Fiber construction offers optimum strength to weight characteristics.
- > Proprietary Robotic Resin Thickness Control combined with a computerized measuring process ensures zero variance between helmets and precise weight uniformity.
- > Precision Robotic Hydro-Jet Cutting Process for all helmet openings eliminates material fatigue which preserves laminate integrity.



VENTILATION CHARACTERISTICS

- > Proprietary Sparco AeroFlow channeling system provides optimal ventilation and air flow throughout the helmet in the most demanding environmental conditions.
- > The WTT System consists of:
 - Four Naca-shaped inlet slots on the chin bar
 - Three reversible inlet/outlet air vents on the crown
 - Two multipurpose exhaust/communication ports



SHIELD TECHNOLOGY

Crystal clear un-obscured vision means better control and comfort.

- > Polycarbonate pre-formed 3 mm. anti-scratch shield.
- > Available in several tint options.
- > Optically correct for distortion free vision.
- > Micro-adjustable pivot with CNC machined aluminum hardware.
- > Elliptical tear-off pins.



AERODYNAMICS

The advanced aerodynamic properties of these new helmets are the result of exhaustive research performed at Fiat's Wind Tunnel Research center in Torino, Italy. Literally hundreds of hours of testing have yielded a design virtually invisible to the wind. Evidence of these aerodynamic achievements is clearly visible throughout the helmet's design.

- > Revolutionary shape virtually eliminates turbulence or buffeting.
- > Optional spoiler kits allow customizing to meet specific aerodynamic needs.



ADVANCED ERGONOMICS

Fit and comfort are crucial elements in the function and overall performance of a helmet.

- > The SurroundSoft comfort system utilizes the optimum density foam in each area of the helmet thus ensuring a proper fitting helmet with maximum comfort.
- > Ultra soft knit NOMEX® interior for ultimate safety and comfort.
- > Optional cheek pads available in various thicknesses enable a custom fit.
- > Completely removable inner liner for easy cleaning and service.

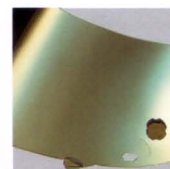

OFFICIAL SPARCO HELMET ACCESSORIES

- > Replacement shields in Smoke and Iridium tints.
- > Lightweight spoilers and stabilizers.
- > Tear-offs.
- > Optional cheek pads for custom fitting.



HANS COMPATIBLE

HANS hardware comes pre-installed on the WTT F1 Carbon.

F1

WIND TUNNEL TESTED
WTT**HANS COMPATIBLE**Specifically engineered platform
for installation of HANS hardware.

SNELL SA 2000 CERTIFIED



APPROVED



Adult Sizes:

XS (53cm - 54cm)	00338F1B1XS
S (55cm - 56cm)	00338F1B2S
M (57cm - 58cm)	00338F1B3M
L (59cm - 60cm)	00338F1B4L
XL (61cm - 62cm)	00338F1B5XL

THE PREMIER SPARCO HELMET.

The F1 has a narrow eye port designed for use in open wheel racing. The F1 comes complete with HANS hardware pre-installed. The F1 also includes our 3mm homologated shield with CNC machined aluminum hardware and positive lock down hinge, removable liner for easy cleaning and service, and lightweight adjustable air ducts.

**SHELL PROPERTIES & TECHNOLOGIES**

- > 100% fiberglass construction offers optimum strength to weight characteristics.
- > Sparco's Vacuum Form Resin Strengthening Process removes air during curing, ensuring a void free laminate.
- > Proprietary Robotic Resin Thickness Control combined with a computerized measuring process ensures zero variance between helmets and precise weight uniformity.
- > Precision Robotic Hydro-Jet Cutting Process for all helmet openings eliminates material fatigue which preserves laminate integrity.

**VENTILATION CHARACTERISTICS**

- > Proprietary Sparco AeroFlow channeling system provides optimal ventilation and air flow throughout the helmet in the most demanding environmental conditions.
- > The WTT System consists of:
 - Four Naca-shaped inlet slots on the chin bar
 - Three reversible inlet/outlet air vents on the crown
 - Two multipurpose exhaust/communication ports

**SHIELD TECHNOLOGY**

- Crystal clear un-observed vision means better control and comfort.
- > Polycarbonate pre-formed 3 mm, anti-scratch shield.
- > Available in several tint options.
- > Optically correct for distortion free vision.
- > Micro-adjustable pivot with CNC machined aluminum hardware.
- > Elliptical tear-off pins.

**AERODYNAMICS**

- The advanced aerodynamic properties of these new helmets are the result of exhaustive research performed at Fiat's Wind Tunnel Research center in Torino, Italy. Literally hundreds of hours of testing have yielded a design virtually invisible to the wind. Evidence of these aerodynamic achievements is clearly visible throughout the helmet's design.
- > Revolutionary shape virtually eliminates turbulence or buffeting.
 - > Optional spoiler kits allow customizing to meet specific aerodynamic needs.

**ADVANCED ERGONOMICS**

- Fit and comfort are crucial elements in the function and overall performance of a helmet.
- > The SurroundSoft comfort system utilizes the optimum density foam in each area of the helmet thus ensuring a proper fitting helmet with maximum comfort.
 - > Ultra soft knit NOMEX® interior for ultimate safety and comfort.
 - > Optional cheek pads available in various thicknesses enable a custom fit.
 - > Completely removable inner liner for easy cleaning and service.

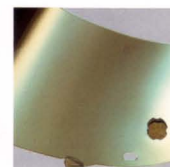
**OFFICIAL SPARCO HELMET ACCESSORIES**

- > Replacement shields in Smoke and Iridium tints.
- > Lightweight spoilers and stabilizers.
- > Tear-offs.
- > Optional cheek pads for custom fitting.

**HANS COMPATIBLE**

The WTT F1 features mounting areas ready for HANS hardware.

TK

WIND TUNNEL TESTED
WTT
 WIDE EYE PORT

HANS COMPATIBLE
 Specifically engineered platform
 for installation of HANS hardware.



SNELL SA 2000 CERTIFIED



Adult Sizes:

XXS (51cm - 52cm)	00338TKBOXXS
XS (53cm - 54cm)	00338TKB1XS
S (55cm - 56cm)	00338TKB2S
M (57cm - 58cm)	00338TKB3M
L (59cm - 60cm)	00338TKB4L
XL (61cm - 62cm)	00338TKB5XL

KF

WIND TUNNEL TESTED
WTT

HANS COMPATIBLE
 Specifically engineered platform
 for installation of HANS hardware.



SNELL SA 2000 CERTIFIED



Adult Sizes:

XS (53cm - 54cm)	00338KFB1XS
S (55cm - 56cm)	00338KFB2S
M (57cm - 58cm)	00338KFB3M
L (59cm - 60cm)	00338KFB4L
XL (61cm - 62cm)	00338KFB5XL

SN2000



SNELL SA 2000 CERTIFIED



Adult Sizes:

XS (53cm - 54cm)	00338B1XS
S (55cm - 56cm)	00338B2S
M (57cm - 58cm)	00338B3M
L (59cm - 60cm)	00338B4L
XL (61cm - 62cm)	00338B5XL

AFFORDABLE SPARCO HEAD PROTECTION.

The Carbon Aramid mix shell of the SN2000 performed extremely well in aerodynamic tests along side our WTT line of helmets. The SN2000 has two Naca-style intake ducts on the chin bar, two adjustable air vents on top plus four exhaust vents on the rear of the helmet. The inner lining has a removable chin curtain for extra comfort on hot days. The SN2000 also includes our 3mm homologated shield with CNC machined aluminum hardware and positive lock down hinge.



SHELL PROPERTIES & TECHNOLOGIES

- > 100% fiberglass construction offers optimum strength to weight characteristics.
- > Sparco's Vacuum Form Resin Strengthening Process removes air during curing, ensuring a void free laminate.
- > Proprietary Robotic Resin Thickness Control combined with a computerized measuring process ensures zero variance between helmets and precise weight uniformity.
- > Precision Robotic Hydro-Jet Cutting Process for all helmet openings eliminates material fatigue which preserves laminate integrity.



VENTILATION CHARACTERISTICS

- > Internal channeling within the polystyrene liner aids in the circulation of air within the helmet.
- > The SN2000 System consists of:
 - Two Naca-shaped inlet slots on the chin bar
 - Two adjustable inlets on the crown.
 - Four exhaust ducts in the rear to eliminate heated air from inside the helmet.



SHIELD TECHNOLOGY

Crystal clear un-obscured vision means better control and comfort.

- > Polycarbonate pre-formed 3 mm. anti-fog shield.
- > Available in several tint options.
- > Optically correct for distortion free vision.
- > Multi-position pivot with aluminum hardware.
- > Elliptical tear-off pins.



AERODYNAMICS

The advanced aerodynamic properties of these new helmets are the result of exhaustive research performed at Fiat's Wind Tunnel Research center in Torino, Italy. Literally hundreds of hours of testing have yielded a design virtually invisible to the wind. Evidence of these aerodynamic achievements is clearly visible throughout the helmet's design.

- > Revolutionary shape virtually eliminates turbulence or buffeting.
- > Optional spoiler kits allow customizing to meet specific aerodynamic needs.



ADVANCED ERGONOMICS

Fit and comfort are crucial elements in the function and overall performance of a helmet.

- > The SurroundSoft comfort system utilizes the optimum density foam in each area of the helmet thus ensuring a proper fitting helmet with maximum comfort.
- > Ultra soft knit NOMEX® interior for ultimate safety and comfort.
- > Optional cheek pads available in various thicknesses enable a custom fit.
- > Completely removable inner liner for easy cleaning and service.

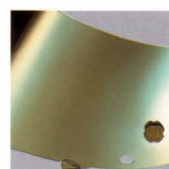

OFFICIAL SPARCO HELMET ACCESSORIES

- > Replacement shields in Smoke and Iridium tints.
- > Lightweight spoilers and stabilizers.
- > Tear-offs.
- > Optional cheek pads for custom fitting.

WTT ACCESSORIES



CLEAR VISOR (STD.)
0032WTT3T



LIGHT SMOKE VISOR
0032WTT3O



DARK SMOKE VISOR
0032WTT3D



ORANGE VISOR
0032WTT3A



YELLOW VISOR
0032WTT3G



GOLD IRIIDIUM VISOR
0032WTT3IGO



BLUE IRIIDIUM VISOR
0032WTT3IAZ



SILVER IRIIDIUM VISOR
0032WTT3IIS



CHEEK PADS (XXS-XL)
0032WTTCK...



NECK CURTAIN
0032WTTNECK...



COMMUNICATION PLUG
0032WTTSP/2



SIDE AIR BEZEL
0032WTTSL/2



SPOILER SET
WHITE 0032WTT6B/2
CLEAR 0032WTT6T/2



STABILIZER SET
WHITE 0032WTT6B/4
CLEAR 0032WTT6T/4



SPOILER - FULL
WHITE 0032WTT5B
CLEAR 0032WTT5T



SPOILER - UPPER
WHITE 0032WTT4B
CLEAR 0032WTT4T



SPOILER/STABILIZER SET
WHITE 0032WTT3B/3
CLEAR 0032WTT3T/3

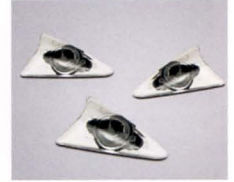

AIR VENT SET
SET OF THREE.
0032WTT3C



VISOR DECALS
SOLD SEPARATELY.
RED - SPVISWTTRS
BLUE - SPVISWTTAZ
BLACK - SPVISWTTNR



TEAR OFFS
SET OF FIVE.
0032WTT05



VISOR PIVOT KIT
0032WTTKV

HELMET CLEANER

Specially formulated, helmet-safe cleaner.
00320D



SN2000 ACCESSORIES



CLEAR VISOR (Std.)
00322B



LIGHT SMOKE VISOR
00322F



DARK SMOKE VISOR
00322D



GOLD/BLUE IRIIDIUM VISOR
00322IGA



BLUE IRIIDIUM VISOR
00322IAZ



SILVER IRIIDIUM VISOR
00322IS



VISOR PIVOT KIT
0032KVFC



SPOILER SET
WHITE
00326B



SPOILER SET
CLEAR
00326T



TEAR OFFS
SET OF FIVE
00320T05



VISOR DECALS
SOLD SEPARATELY.
RED - SPVISSNRS
BLUE - SPVISSNAZ
BLACK - SPVISSNNR



AIR VENT SET
0032SN2C

HELMET BAGS

3112NGR

Constructed of strong, lightweight materials for years of use, with numerous pockets.

BLACK / GREY

003112NGR



BLACK / GREY

003122NN



3122 PROFESSIONAL

Sparco's latest design. Enough pockets for all your extras. High density foam for the best helmet protection available.

TOP TECHNOLOGY



SPARCO CARBON SEATS ARE MANUFACTURED UTILIZING THE SAME TECHNOLOGY AS SEEN IN FORMULA ONE, WRC, CART, IRL AND THE SPACE SHUTTLE

When it comes to driving seats, only the hard facts count. Seats are subjected to enormous stress loads which are comparable to those placed on the engine. High performance seats enable the driver and car to function in unison.

Sparco is undeniably the most reliable, technically advanced and experienced manufacturer of racing car seats in the world. These results have been made possible by our enormous investment in our research and development laboratories. Samples of frames and shells are taken daily at random, from the production lines and are subjected to destruction tests. Special machinery specifically designed by our technicians, put our seats to the test, to ensure that all components meet the highest standards of resistance and safety.

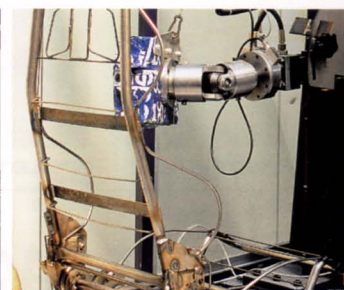

S-LIGHT CIRCUIT

THE EPITOME

of our commitment to seat technology.

For many years Sparco seats have been the benchmark in racing seat quality, comfort and applied technology. The S-light continues that long standing tradition. The shell has been developed in our new state of the art production facility. The S-Light has a Carbon fiber honeycomb composite shell that can withstand stresses of over 2200 pounds. Many other special features are also included such as fire retardant covers with anti-slip fabric in shoulder and seat area, split adjustable thigh cushions, special shock absorbing material in the head and side areas, plus HANS compatibility.



APPROVED



BLACK
00892ZNR

S-LIGHT



APPROVED



BLACK
00893ZNR

CIRCUIT



Truly
THE ULTIMATE
competition seat.

Developed in collaboration with the top racing teams in the world, the unique design of the Circuit offers the driver the ultimate in comfort, control and protection. The integrated impact absorbing head restraint feature combined with unparalleled lateral support, the Circuit is fast on its way to becoming the most widely used seat in road and rally racing. Other features include fire retardant covers with anti-slip fabric in shoulder and seat area, pre-formed thigh support to keep legs in the optimum position, special shock absorbing material in the head and side areas, plus HANS compatibility.



RED
00892FRS



BLUE
00892FAZ



NAVY
00892FBS



BLACK
00892FNR

CORSA



Sparco's
AGGRESSIVE
new design.

Designed in conjunction with the top World Rally Championship Drivers this competition seat offers maximum side support. Its unique design will provide the most demanding of drivers with the ultimate in safety and performance. It is available both in carbon or fiberglass and with side mounting only. FIA homologated.



APPROVED



RED
00887FRS

BLUE
00887FAZ

NAVY
00887FBS

BLACK
00887FNR

PRO 2000



The
WINNING DEBUT
in racing worldwide.

The Pro 2000 has won every major touring car and sports car championship in the world and is used by the top factory sportscar and rally teams. Available in fiberglass or carbon fiber. Excellent lateral grip on the whole of the body, very comfortable, equipped with special, adjustable lateral lumbar supports.



APPROVED



RED

CARBON FIBER
FIBERGLASS

N/A
00857FRS

BLUE

N/A
00857FAZ

NAVY

N/A
00857FBS

BLACK

00857ZNR
00857FNR

EVO

Sparco's DRIVING BREAKTHROUGH in racing seat design.

Evolved from the Rev seat, designed and developed in co-operation with the most prestigious Sparco drivers of the DTM and BTCC Championships. Designed specially for a "free" driving position, even in extreme competition conditions. The special shape of the shell and the new construction technology which "sandwiches" carbon-kevlar-carbon, have given increased rigidity for excellent driving sensibility (while keeping the weight extremely low). Films of homologation crash tests performed by the FIA confirm the Evo's first place in the rigidity/resistance ratio impact tests.



	RED	BLUE	NAVY	BLACK
CARBON FIBER FIBERGLASS	N/A	N/A	N/A	
	00858FRS	00858FAZ	00858FBS	00858ZNR 00858FNR

EVO 2 & EVO 3

Exclusively for the LARGER DRIVER in mind.

The same design as Evo, the Evo 2 and Evo 3 are built with the larger driver in mind. They are 1/4" and 2 1/2" respectively wider than the Evo. Available only in fiberglass.



	RED	BLACK
EVO 2	00859FRS	00859FNR
EVO 3	00856FRS	00856FNR

REV 5 PLUS



Sparco's racing
LEGEND
now HANS compatible.

Sparco's revolution in the field of racing seats, used by many official teams (Ford, Alfa Romeo, Peugeot, Nissan, Renault and many others) in World Rally Championships and important Touring Car Championships. Manufactured with sophisticated production techniques and revolutionary materials which guarantee it to be light-weight, comfortable and strong.



RED
00865FRS



BLUE
00865FAZ



NAVY
00865FBS



BLACK
00865FNR

SPRINT

The Sprint has become the most affordable and widely used competition seat in the world. Constructed with a tubular steel frame, the Sprint offers unequalled support and safety at an entry level price.



RED

00820RS

BLUE

00820AZ

BLACK

00820NR

ULTRA

Made of fiberglass, this seat, specially designed to improve comfort, is characterized by a distinctive type of upholstery that creates a micro-channeling effect of air between the seat and the driver's body, which, together with the perfect ergonomics, make it extremely comfortable. The combination of new assembly techniques, the padding and the upholstery allow us to offer it at an incredibly low cost.



RED

00833RS

BLUE

00833AZ

BLACK

00833NR

ALLROAD

A new addition to the Sparco seat line up. The Allroad offers you a high quality abrasion resistant vinyl cover. This cover can also be removed, and replaced if needed after many years of use. The seat also provides you with lower lateral support and outstanding shoulder reinforcement. The improved side lower thigh support structure was angulated to allow you easier entry and exit out of your vehicle. The Allroad seat is slightly wider than the Sprint.



RED

00841RS

BLUE

00841AZ

BLACK

00841NR

SEAT ACCESSORIES

COLOR SEAT INSERTS

For the seats Pro 2000, Rev and Evo it is possible to buy the backrests, the cushion and the leg rest in a single kit, customizing the seat with dynamic colors. The kit, which is easily fitted, is available in blue, red, green, yellow, grey and black.

PRO 2000	EVO	REV
01042	01043	01041



OPTIONAL PADDING

Offered to allow each driver the ability to adapt the seat to his or her own personal characteristics. Velcro attachment for easy installation and adjustment. Available in most standard seat colors.

SEAT CUSHION (not shown)
BLACK KINDER POINT (ONLY)

01031



ADJ. PNEUMATIC LUMBAR
BLACK (ONLY)

01027NR

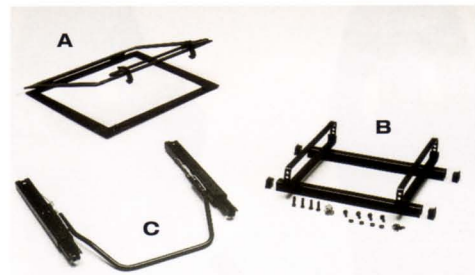

UNIVERSAL BASE ASSEMBLIES

- A** 00494 Tilt Adapter. Fits between sliders and seat base, allows a fixed back seat to be tilted forward.
- B** 00491 Universal Base Mount. For use when original sliders can be removed from the seat. Also allows height adjustment.
- C** 00493 Universal Sliders. Double locking, FIA homologated. Fits all Sparco seats.

HELMET CUSHION

01008



LEG CUSHION

01011



CENTER LUMBAR CUSHION

01023



SIDE KIDNEY / LUMBAR CUSHION

01022



ALUMINUM SIDE MOUNTS

BLACK
00490W



STEEL SIDE MOUNTS

RED
00490RS

BLACK
00490NR

Custom fit
HARNESS BARS
 for 3" harnesses.

Sparco harness bars are manufactured with the highest quality .120-wall steel and designed specifically for our competition 3" harnesses. They are MIG welded by our highly skilled technicians, and engineered to strict safety standards.

Included in the kit are driver's side and passenger side vertical reinforcement tubes. These tubes mount to the base of your B pillar and connect to your harness bar. This helps to anchor the harness bar and creates a triangular reinforcement structure. The triangulation prevents the bar from any vertical movement and keeps the harness bar in place and level at all times. After these pieces are combined the bar also helps to stiffen your chassis dynamics and improves the overall handling characteristics of your vehicle. This unique design also allows you to retain most of the space in the back seat area of your vehicle.



PART#	MAKE	MODEL	YEAR	NOTE
30013G	ACURA	INTEGRA 2DR	94-01	Grey
30013S	ACURA	INTEGRA 2DR	94-01	Silver
30006G	BMW	E30	80-91	Grey
30006S	BMW	E30	80-91	Silver
30007G	BMW	E36 COUPE	92-99	Grey
30007S	BMW	E36 COUPE	92-99	Silver
30009G	BMW	M COUPE		Grey
30009S	BMW	M COUPE		Silver
30010G	CHEVY	CORVETTE C4	95-98	Grey
30010S	CHEVY	CORVETTE C4	95-98	Silver
30011G	CHEVY	CORVETTE C5/Z06		Grey
30011S	CHEVY	CORVETTE C5/Z06		Silver
30012G	FORD	MUSTANG	95-03	Grey
30012S	FORD	MUSTANG	95-03	Silver
30015G	HONDA	CIVIC	92-00	Grey
30015S	HONDA	CIVIC	92-00	Silver
30016G	HONDA	PRELUDE	97-01	Grey
30016S	HONDA	PRELUDE	97-01	Silver
30018G	MITSUBISHI	EVO	03+	Grey
30018S	MITSUBISHI	EVO	03+	Silver
30002G	PORSCHE	911	69-73	Grey
30002S	PORSCHE	911	69-73	Silver
30001G	PORSCHE	911	74-98	Grey
30001S	PORSCHE	911	74-98	Silver
30003G	PORSCHE	911 TRG	74-88	Grey
30003S	PORSCHE	911 TRG	74-88	Silver
30004G	PORSCHE	996		Grey
30004S	PORSCHE	996		Silver
30017G	SUBARU	WRX	01-03	Grey
30017S	SUBARU	WRX	01-03	Silver
30014G	TOYOTA	SUPRA	93-98	Grey
30014S	TOYOTA	SUPRA	93-98	Silver
30000		EXTINGUISHER MOUNT		

COMPETITION HARNESSSES



A new partnership between SPARCO & SCHROTH

Sparco is proud to announce a new technical partnership with Schroth Racing. At Sparco we strive to bring you the safest most technologically advanced products available. This new partnership will allow us to do just that. For nearly 50 years Schroth has been a leading manufacturer safety harnesses. In 1960 Schroth began conducting simulated crash tests. These tests produced advancements in product quality and performance to meet ever increasing racing safety requirements. With the knowledge gained in this extensive testing Schroth has become the technology leader in competition harnesses. Sparco has long been recognized as the dominant manufacturer in the field of automotive seating. The technical collaboration with Schroth and our combined worldwide presence in the racing community will allow us to achieve greater advancements in seating and safety restraint systems.



PROTECTIVE 3" CUSHIONS



RED 01098S3R **YELLOW** 01098S3G **BLUE** 01098S3A **BLACK** 01098S3N

LAP BELTS

Sparco 3" competition harnesses are used by some of the most popular Formula One, IndyCar and Sports Car teams. Sparco lap belts feature an aircraft quality spring loaded quick release camlock system. This system ensures immediate evacuation in case of vehicle fire. Available in both pull up, and pull down styles. All belts are FIA & SFI homologated.

WARNING:

It is strongly recommended that the shoulder harnesses are fitted as close to horizontal as possible. It is a must that the angle of the shoulder harness does not exceed 45 degrees in relation to the theoretical horizontal axis of the mounting points. It is recommended that the harnesses be mounted to the fixing points suggested by the car manufacturer. The fixing points should always be reinforced by a steel plate fitted on the outer side of the car, not by welding or pop riveting. After an accident or a heavy crash, it is a must to replace the harnesses and carefully re-check their fixing points in the car. Belts should not be in contact with parts which can damage them. Should the belt show any wearing or cuts, it must be immediately replaced.

IMPORTANT ASSEMBLY INSTRUCTIONS

Do not fix the belt straps in the areas indicated NO! In the event of collisions, the belt would fail to hold the driver's body, and may cause the seat to break.

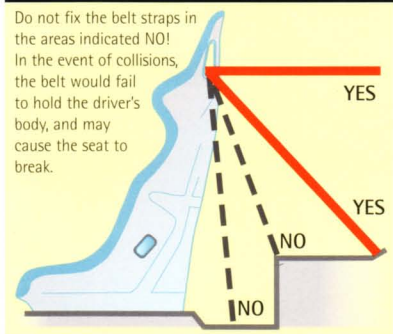

HARNESS MOUNTING KITS

SNAP-IN KIT

049102



BOLT-IN KIT

049101



PROFESSIONAL 3" NOMEX® CUSHIONS



RED 01092L34S3RS **BLUE** 010292L34S3AZ **BLACK** 01092L34S3NR

PULL-DOWN STYLE LAP BELTS



BLACK
049002NR



RED
049002RS



BLUE
049002AZ

PULL-UP STYLE LAP BELTS



BLACK
049001NR



RED
049001RS



BLUE
049001AZ

ANTI-SUB BELTS

Sparco single and dual sub belts assist the lap belt to further anchor the driver in place. Anti-sub belts are crucial in preventing the lap belt from rising and to ensure proper placement of your safety harness system. All belts are FIA & SFI homologated.



5-POINT BLACK 04195NR 5-POINT RED 04195RS 5-POINT BLUE 04195AZ 6-POINT BLACK 04196NR 6-POINT RED 04196RS 6-POINT BLUE 04196AZ

48" SHOULDER HARNESS

Sparco 48" shoulder harnesses are ideal for use in vehicles that have roll cages with the horizontal cross bar fabricated directly behind the drivers seat. All harnesses are FIA & SFI homologated.



48" BLACK 049005NR 48" RED 049005RS 48" BLUE 049005AZ

75" SHOULDER HARNESS

Sparco 75" shoulder harnesses are ideal for use in vehicles with the horizontal cross bar fabricated near the rear of the vehicle. All harnesses are FIA & SFI homologated.



75" BLACK 049006NR 75" RED 049006RS 75" BLUE 049006AZ

Ø 260MM

Dish 30mm



Ø 270MM

Dish 30mm



Grip Color
Grip Material
Spoke Color

BLACK
SUEDE
BLACK ANODIZED
015P260FSN

BLACK
LEATHER
BLACK ANODIZED
015P270LN

BLACK
SUEDE
BLACK ANODIZED
015P270SN

Ø 280MM

Dish 30mm



Ø 285MM

Dish 30mm



Grip Color
Grip Material
Spoke Color

BLACK
SUEDE
BLACK ANODIZED
015P280FSN

BLACK
SUEDE
BLACK ANODIZED
015P285SN

Ø 300MM

Dish 30mm



Grip Color
Grip Material
Spoke Color

BLACK
SUEDE
BLACK ANODIZED
015P300SN

Ø 310X260MM



BLACK
SUEDE
BLACK ANODIZED
015P310F2SN

323

Ø 330mm Dish 39mm



Grip Color
Grip Material
Spoke Color

BLACK
SUEDE
BLACK ANODIZED
015R323PSNR

333

Ø 330mm Dish 39mm



BLACK
SUEDE
BLACK ANODIZED
015R333PSNO

353

ø 330mm | Dish 36mm

Grip Color
Grip Material
Spoke Color**BLACK**
SUEDE
BLACK ANODIZED

015R353PSN

383

ø 330mm | Dish 39mm

**BLACK**
LEATHER
BLACK ANODIZED

015R383PSN

375

ø 350mm | Dish 36mm

Grip Color
Grip Material
Spoke Color**BLACK**
SUEDE
BLACK ANODIZED

015R375PSN

368

ø 380mm | Dish 65mm

**BLACK**
SUEDE
BLACK ANODIZED

015R368MSN

215

ø 350mm Dish 90mm

Grip Color
Grip Material
Spoke Color**BLACK**
SUEDE
BLACK ANODIZED
015R215CSN**BLACK**
LEATHER
BLACK ANODIZED
015R215CLN**325**

ø 350mm Dish 95mm

**BLACK**
SUEDE
BLACK ANODIZED
015R325CSN**BLACK**
LEATHER
BLACK ANODIZED
015R325CLN**345**

ø 350mm Dish 63mm

Grip Color
Grip Material
Spoke Color**BLACK**
SUEDE
BLACK ANODIZED
015R345MSN**BLACK**
LEATHER
BLACK ANODIZED
015R345MLN**PULSAR**

ø 310x260mm Dish 35mm

**BLACK**
SUEDE
BLACK ANODIZED
015T31CF2SN

RING

ø 330mm Dish 35mm



Grip Color **BLACK**
 Grip Material **SUEDE**
 Spoke Color **BLACK ANODIZED**
 015TRGS1TUV

BLACK
 LEATHER
 BLACK ANODIZED
 015TRGL1TUV

FASTER

ø 330mm Dish 35mm



Grip Color **DARK RED**
 Grip Material **LEATHER**
 Spoke Color **BRUSHED ALUMINUM**
 015TFSLRB

BEIGE
 LEATHER
 BRUSHED ALUMINUM
 015TFSLBE

BLACK
 LEATHER
 BRUSHED ALUMINUM
 015TFSLNR

RACER 2

ø 330mm Dish 35mm



Grip Color
Grip Material
Spoke Color

RED
ALCANTARA
BLACK ANODIZED
015TR2A5TUV

BLUE
ALCANTARA
BLACK ANODIZED
015TR2A7TUV

BLACK
ALCANTARA
BLACK ANODIZED
015TR2A1TUV

STEERING WHEEL SPACERS

The Sparco steering wheel spacer is perfect for the driver who prefers the steering wheel closer to the chest. All spacers are CNC machined from the highest quality aluminum, anodized and are 50mm in length.



BLACK 01595ANR **RED** 01595ARS **POLISHED** 01595CRO **BLUE** 01595AAZ **SILVER** 01595ANT

HUBS

01502...



STEERING WHEEL RINGS

The perfect accent for the car show competitor that is seeking the ultimate interior detail.



BLUE ANODIZED 01599AZ **BLACK ANODIZED** 01599NR **RED POWDER COAT** 01598RS **GREY POWDER COAT** 01598GR **BLACK POWDER COAT** 01598NR

QUICK RELEASE HUBS



GOLD 6-POINT WELD ON 015R99TR **GOLD 3-POINT WELD ON** 015R99FM **GOLD 6-POINT BOLT ON** 015R99GN

EXTERNAL HORN BUTTON KITS

These Horn Button Kits are perfect for controlling your NOS, Line Lock, scramble boost or any other electrical feature in your car that requires instant access. Available in single or dual combinations.



015NE982

015NE981



BLACK 6-POINT BOLT ON
015R99TU

AFFF FIRE SYSTEMS

TOURING & RALLY 02000 (AFFF), FIA APPROVED

Sparco touring and rally car fire systems feature the 02000 foam extinguishing agent AFFF (aqueous film forming foam). 02000 smothers the fire with a fine mist that coats the area extinguishing the fire and laying a film that cools the surface and prevents re-ignition. It is environmentally friendly, non-toxic, non-ozone depleting, non-corrosive and biodegradable. 02000 is approved by the FIA, and SCCA. Available in 4 liter cylinders, each system is supplied with all components for a simple and professional installation. 2 actuating types are offered, pull cable or electrical.

SYSTEM FEATURES:

- Aluminum Cylinders
- Quick release push fitting FO2
- Aluminum anodized bracket with stainless steel straps
- Compact firing heads
- Total discharge activation
- Fully flexible internal pickup tube
- Specially designed nozzle which divides the foam into fine particles

PULL CABLE SYSTEM INCLUDES:

- 5 Meters Semi-Rigid Alloy Tubing
- x1 Pack of Tube Clips
- 12ft. T-handle Cable
- 6ft. T-handle Cable
- Mounting Brackets
- x3 'T' fittings
- x4 Nozzles
- Decal Pack



HOMOLOGATED

ELECTRICAL SYSTEM INCLUDES:

- x2 Electrical Connectors & Leads
- 5 Meters Semi-Rigid Alloy Tubing
- x1 External Waterproof Switch
- x1 Pack of Tube Clips
- Mounting Brackets
- x1 Cockpit Switch
- x1 Power Pack
- x3 'T' Fittings
- x4 Nozzles
- Decal Pack



HOMOLOGATED

MECHANICAL 4.0 LITRE

PAINTED ALUMINUM

160mm DIAMETER

014FIA002

ELECTRICAL 4.0 LITRE

POLISHED ALUMINUM

160mm DIAMETER

014FIA004

HALON 1211 FIRE SYSTEMS



CIRCLE TRACK & ROAD RACE HALON 1211, DOT APPROVED

Sparco is now offering a full range of high quality Halon fire systems for the United States market. Sparco fire systems are manufactured to the highest possible standards offering unbeatable quality and value for the money. Available in cylinders with 5 or 10lbs. capacities, each system is supplied with all components for a simple and professional installation. Two actuating types are offered: pull cable or electrical.

PULL CABLE SYSTEM INCLUDES:

- 4 Meters Semi-Rigid Alloy Tubing
- x1 Pack Tube Clips
- Mounting Brackets
- 6ft. Pull Cable
- x5 'T' Fittings
- x2 Nozzles
- Decal Pack



ELECTRICAL SYSTEM INCLUDES:

- x4 Meters Semi-Rigid Alloy Tubing
- x2 Electrical Connectors & Leads
- x1 Shrouded Cockpit Switch
- Mounting Brackets
- x1 Pack Tube Clips
- x1 Power Pack
- x1 'T' Fittings
- x2 Nozzles
- Decal Pack



PULL CABLE
PAINTED ALUMINUM
5lbs.

014EPOV0025

PULL CABLE
PAINTED ALUMINUM
10lbs.

014EPOV00210

ELECTRICAL
PAINTED ALUMINUM
5lbs.

014EPOV0035

ELECTRICAL
PAINTED ALUMINUM
10lbs.

014EPOV00310

SHIFT KNOBS

												
RACING	RED	CHROME	SILVER	BLUE	CARBON	GLOBE-R	CHROME	GLOBE-X	BLACK	BLACK	BLUE	RED
	03740RS	03740CR	03740AN	03740AZ	03740CL		03745CR		03745PTN	03745XLMN	03745XLSB	03745XLSR
												
EASY	BLUE	CLEAR	BLACK	LITUM	BLACK	RED	GREY	BLUE	GREY	RED	SILVER	BLUE
	03751AZ	03751BI	03751NR		03743LNRNR	03743LNRRS	03743LNRGR	03743LNRAZ	03742LNGR	03742LNRS	03742LNGR	03742LNAZ
												
X-FAST	SILVER	GREY	FAST-R	SILVER	GREY	ERGON	BLACK/SILVER	ROAD	POLISHED	POLISHED		
	03748AN	03748GR		03749AN	03749GR		03739TI		03751RCRNR	03753CRNR		

PEDAL KITS

					
GRIP	NATURAL ALUMINUM		CARBON	CARBON FIBER	INCLUDES ANTI-SLIP INSERTS
	03787BRI			03783L	
					
RACE	BLUE	RED	SILVER	CORSA	BLACK
	03779AZ	03779RS	03779AN		03775

PRO TEAM

The latest addition to Sparco Mechanics suit lineup. Box quilted and cotton lined, this mechanic suit is made from a polyester/cotton blend (non-fireproof) that ensures a comfortable fit as well as long lasting characteristics. Features VELCRO® ankle fastening, comfort stretch panels, padded knees, extra pockets on leg and chest. Add the professional look to any team.

ADULT SIZES

S - XXL



BLACK
002061...

TOP TECH EVOLUTION

The Top Tech is similar in design to the world famous Sparco 2 racing suit. Single layer without quilting, this suit is made from a highly resistant polyester/cotton blend (non-fireproof). Features elastic cuffs and ankles, and two large pockets. Adds that professional touch to any individual or team.

ADULT SIZES

S - XXL



Similar in design to the Sparco 2 racing suit. Box quilted and cotton lined, this mechanic suit is made from a polyester/cotton blend (non-fireproof) that ensures a comfortable fit as well as long lasting characteristics. Features VELCRO® ankle fastening, padded knees, extra pockets on leg and chest and two radio clip slots. An ideal suit to add that professional look to any team.

ADULT SIZES

S - XXL



RED
00202RS...

BLUE
00202AZ...

GREY
00202GR...

BLACK
00202NR...

RED
00206RS...

BLACK
00206NR...

BLUE
00206AZ...

HOBBY PIT STOP

A budget minded mechanic overall. This is a single layer polyester/cotton (non-fireproof) suit that features elastic closures at the cuffs and ankles, zippered pockets and an attractive two-color design.

ADULT SIZES

S - XXL

Made from high quality polyester/cotton fabric and extremely durable, this suit is also recommended for indoor karting. (Not homologated)

ADULT SIZES

S - XXL



BLUE/GREEN 00201AZ...
RED/GREY 00201RS...
BLACK/RED 00201NR...

BLACK 002002...NR
RED 002002...RS
BLUE 002002...AZ



BLUE 002092...A
RED 002092...R
BLACK 002092...N

MECA 2 GLOVES

The ultimate mechanics' glove with all the durability you need and the feel you want. Breathable fabric back with Alcantara Suede palm will keep you wrenching all day long.

ADULT SIZES

S - XXL



COTTON PIT GLOVES

Comfortable cotton stretch fit allows flexibility for handling small objects with blue rubber peening on palms and fingers. Short gauntlet, white only.

00207

NOMEX® PIT GLOVES

One of the only work gloves entirely made of fire-resistant NOMEX®. Very sensitive, with blue rubber peening for better grip in the palm. Long gauntlet, white only.

00210LNx

KEVLAR PIT GLOVES

The only work gloves entirely made of Kevlar. Extra-long gauntlet, yellow only.

00205

MECHANIC APRON

100% cotton mechanic's apron with pockets and adjustable fastening clips.



BLUE 00215A
BLACK 00215N

ROAD ACCESSORIES

PIT BOARD

Aluminum frame, holds four rows of fluorescent yellow numbers and letters. Provides high visibility and is the same pit board used by the world's top professional teams.



PIT BOARD **NUMBERS**
00593 00592

HOOD PINS

01606S - Pair of steel fasteners with guide pin and trip shutter.
01606A - Pair of anodized blue or red alloy fasteners with guide pin and trip shutter.
01608 - Pair of stainless steel fasteners with spring.



SILVER **BLUE** **RED** **SILVER**
01606S 01606AA 01606AR 01608

MUD FLAPS

Heavy duty material, available in 3 colors. Two Mud Flaps per set, with Sparco stickers.

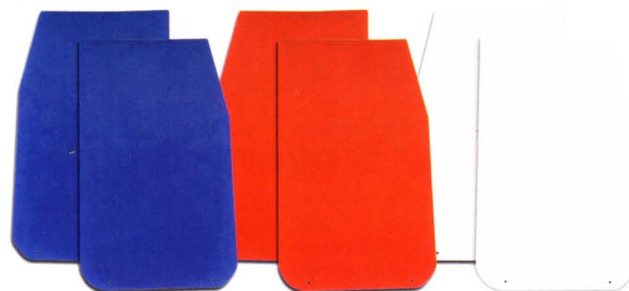

BLUE **RED** **WHITE**
03791AZ 03791RS 03791

BATTERY SWITCH

6-pole, with alternator protection.

BATTERY SWITCH
01335



WINDOW NET

BLACK

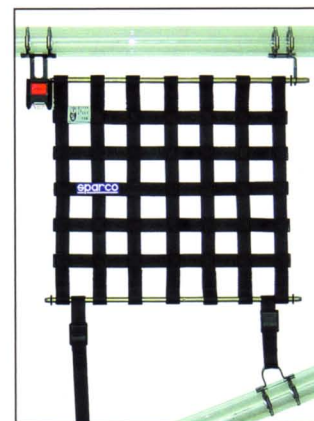

COMBO

ADULT SIZES
S - XXL



BLUE
01121AAZ

RED
01121RGR

BLACK
01121NGR

EIGER

ADULT SIZES
S - XXL



BEIGE
011280BE

NAVY
011280BM

BLACK
011280NR

ACTION

ADULT SIZES
S - XXL



GREY
011290GR

RED
011290RS

NAVY
011290BM

BLACK
011290NR

GEAR BAGS

JOURNEY BAG

This is the perfect weekend bag ideal for storing items for a small weekend trip. It has an adjustable shoulder strap, and external outer mesh pockets for quick storage. It also fits perfectly in any airlines overhead storage compartments.

BLACK
016422NR



JUMBO BAG

This bag was built for the racer, by the racer. It features function specific compartments to store all of your racing equipment and supplies. The Jumbo has separate compartments for your helmet, shoes, gloves, tear offs, and suit. It also includes inner mesh storage compartments to help ventilate any damp articles of racing apparel.

BLACK
016421NR



TEAM 2

Ideal for fast travel, the Team 2 is the perfect size for a weekend away. The Team 2 features several compartments including separate holders for pens, cards and personal items. Complete with lock, shoulder strap, pull out handle and urethane wheels.

BLACK
016402N



TRIP

Sparco's large and light gear bag. The Trip has three separate compartments and abundant space for your gear. Lightweight durable nylon will give years of trouble free travel. 27x15x14

BLACK/GREY
01652NGR



CITY DELUXE BACKPACK

This backpack has every thing you could possibly ask for. Features include ergonomically formed shoulder straps, a separate detachable lap top protection case, and a small front pocket to store all your necessary items. This backpack also features a preformed molded bottom to help keep everything in its proper place.

BLACK
SPO16520N



DIRECTOR

Ideal for student or working professional. Carry your laptop, books, papers and all your accessories. The Director features several compartments, including a cell phone holder as well as separate pen, pencil and card holders.

BLACK
O16424NR



FITNESS

A simple and durable toss everything in and go style duffel. Perfect carry-on size the Fitness is made with heavy duty water proof nylon. It has a separate zippered lower section and a zippered pocket on the outside.

BLACK
O1641





WORLD TOUR

Color **WHITE GREY NAVY BLUE**
 Size **M-XL**
 SP01100B SP01100GR SP01100BS



PHANTOM

Color **WHITE GREY NAVY BLUE**
 Size **M-XL**
 SP01200B SP01200GR SP01200BS



CLOSE

Color **WHITE YELLOW ORANGE**
 Size **M-XL**
 SP01400B SP01400GI SP01400AO



WWW.

Color **WHITE GREY BLACK**
 Size **M-XL**
 SP01300B SP01300GR SP01300NR



TACH

Color **WHITE RED BLACK**
 Size **M-XL**
 SP01600B SP01600RS SP01600NR



EVOLVE

Color **BLACK/BLUE BLACK/RED ROYAL BLUE**
 Size **M-XL**
 SP01700NRAZ SP01700NRRS SP01700R00R



ASPIRE

Color **GREY NAVY BLUE BLACK**
 Size **M-XL**
 SP01800GR SP01800BM SP01800NR



ROLLING

Color **BLACK RED NAVY BLUE**
 Size **M-XL**
 SP01900NR SP01900RS SP01900BA



ICON HOODIE

BLACK ADULT M-XXL SP03000NR	WHITE ADULT M-XXL SP03000B	GREY ADULT M-XXL SP03000GR	NAVY BLUE ADULT M-XXL SP03000BM	RED ADULT M-XXL SP03000RS
------------------------------------------	-----------------------------------------	-----------------------------------------	----------------------------------------------	----------------------------------------



WWW. HOODIE

BLACK ADULT M-XXL SP03100NR	WHITE ADULT M-XXL SP03100B	GREY ADULT M-XXL SP03100GR	NAVY BLUE ADULT M-XXL SP03100BM	RED ADULT M-XXL SP03100RS
------------------------------------------	-----------------------------------------	-----------------------------------------	----------------------------------------------	----------------------------------------



FLEX FIT ICON HAT

BLACK
ADULT S-M / L-XL
SP11N / SP12N

WHITE
ADULT S-M / L-XL
SP11B / SP12B

YELLOW
ADULT S-M / L-XL
SP11G / SP12G

RED
ADULT S-M / L-XL
SP11R / SP12R



X-LIGHT MECA SHOE

BLACK/GREY
ADULT SIZES 39-46
00120ML...

RED/BLACK
ADULT SIZES 39-46
00120ML...



OUT-LANE SHOE

BLACK/RED
ADULT SIZES 39-46
00120L...

BLACK/BLUE
ADULT SIZES 39-46
00120L...

CUSTOM SUITS

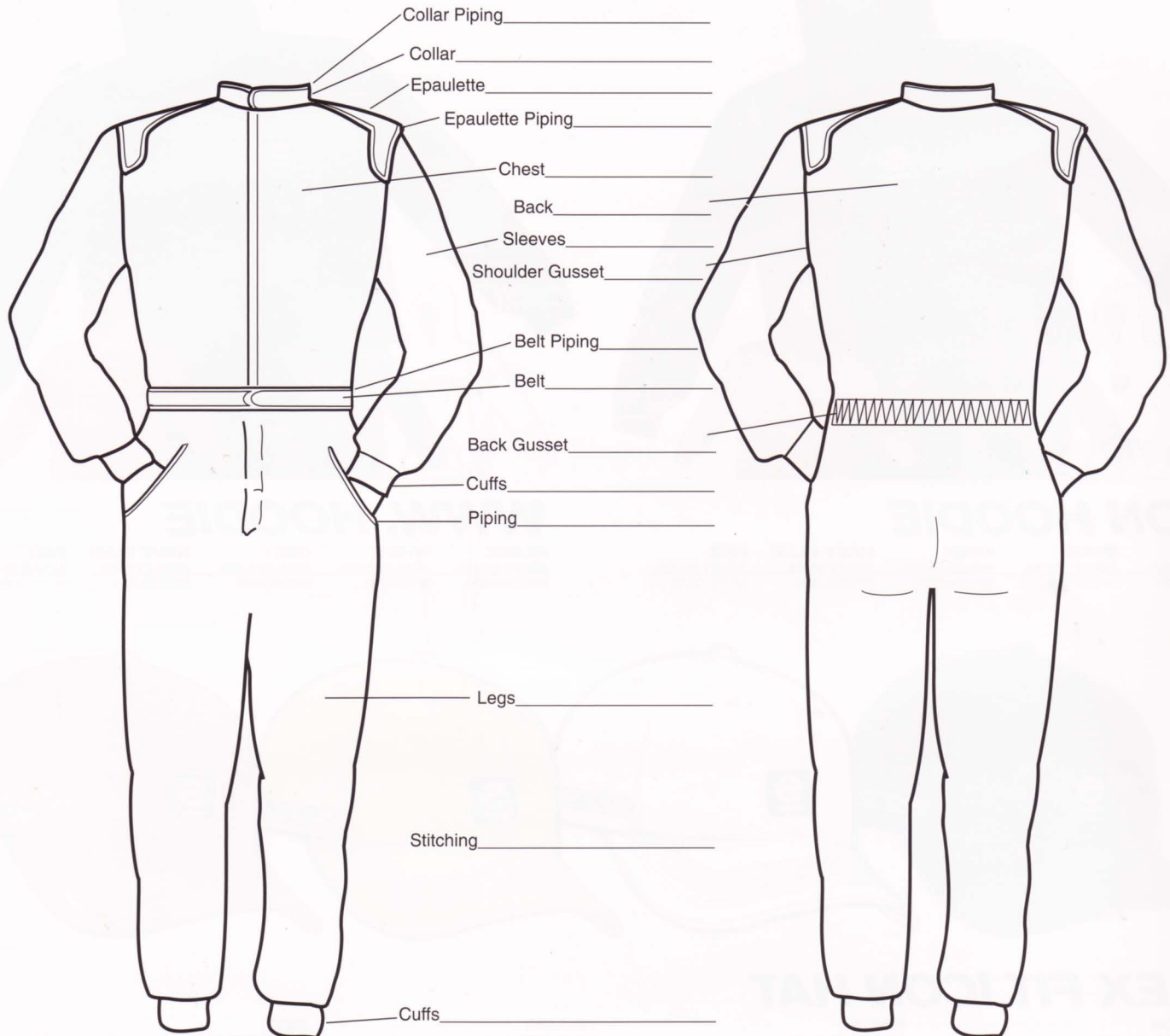

CUSTOM SUIT CHARGES

Custom suit price quotes are estimates only and are subject to a 10% variance. Please allow 6-8 weeks for delivery from the date the order is placed. The order date will be set when all required information is received. *This pricing is a guideline only. Please submit a design sheet for an accurate quote.*

SPECIAL ORDER SUITS

Minimum additional charge: \$175.00

This includes the following changes:

- Made to measure
- Color changes to Piping, stitching, cuffs, collar, and epaulettes. (Does not include any design change to a standard suit)

OTHER ADDITIONAL OPTIONS

(Added to minimum suit charge):

1. Boot cuffs \$125.00
2. Collar style change \$50.00
3. Name and Flag \$50.00
4. Arm Restraints \$175.00

SUIT SIZING REFERENCE

REFER TO THE CHART BELOW TO DETERMINE YOUR SIZE. IF YOU FALL IN BETWEEN SIZES, OPT FOR THE LARGER SIZE.

European Sizing	130	140	150	46	48	50	52	54	56	58	60	62	64	66
American Sizing	XXS		XS		SMALL		MEDIUM		LARGE		XL		XXL	
Chest Circumference (in.)	27	30	32	35	36	38	39	41	42	44	45	46	47	48
Waist Circumference (in.)	24	26	28	29	30	31	32	34	36	38	40	42	44	46
Hip Circumference (in.)	29	31	33	35	36	38	39	41	42	44	45	47	48	49
Height (in.)	49-53	54-57	58-61	62-64	63-65	65-67	67-69	68-71	69-72	71-73	72-74	73-75	74-76	76-78
Weight (lbs.)	65-80	80-100	100-110	110-120	120-130	130-140	140-150	150-165	160-180	175-190	185-205	195-225	215-235	225-250

SEAT DIMENSIONS



SEAT DIMENSION GUIDE

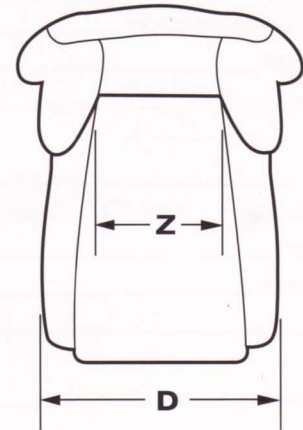
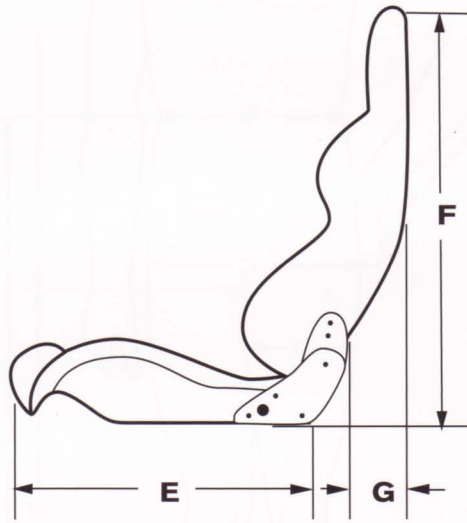
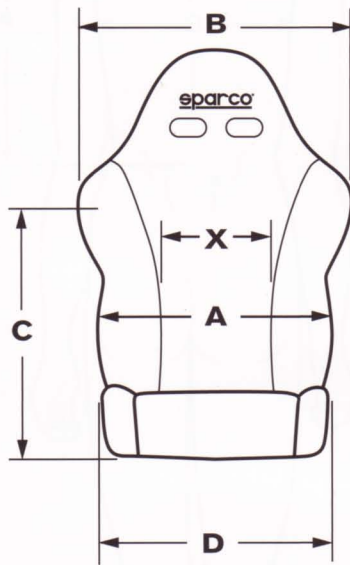

Model	Name	Construction	Homol	N° OMOL.	Driver Size	Bottom Mount	Side Mount	A	X	B	C	D	Z	E	F	G	LBS.	
820	SPRINT	Steel Tube	FIA	CS.954.99	M	271 x 345	NO	17.09	13.07	20.51	23.03	19.72	13.86	20.28	34.06	5.28	18.00	
833	ULTRA	Fiberglass	FIA	CS.916.98	M+L	271 x 345	NO	18.15	10.83	19.33	22.64	19.49	11.61	19.49	33.50	7.99	15.00	
838SKY	OFF ROAD	Fiberglass	FIA	CS.916.98	M	271 x 345	NO	17.52	11.61	19.41	22.44	19.33	12.99	19.69	33.27	7.56	16.50	
841	ALL ROAD	Steel Tube	/	/	M+L	271 x 345	NO	18.00	14.00	20.70	23.00	20.50	14.70	20.50	34.00	5.30	18.50	
856F	EVO 3	Fiberglass	/	/	XL	NO	NO	11.45	20.47	13.78	25.59	23.62	22.83	17.32	20.08	34.65	5.91	22.00
857F	PRO 2000	Fiberglass	FIA	CS.917.98	M+L	271 x 345	NO	11.45	18.66	12.80	23.50	22.44	19.37	13.66	21.06	35.67	3.94	21.50
857Z	PRO 2000	Carbon	FIA	CS.951.99	M+L	271 x 345	NO	11.45	18.66	12.80	23.50	22.44	19.37	13.66	21.06	35.67	3.94	14.50
858F	EVO	Fiberglass	FIA	CS.918.98	M	NO	NO	11.45	18.11	11.81	23.62	24.02	19.69	14.57	18.11	35.04	2.17	18.50
858Z	EVO	Carbon	FIA	CS.957.99	M	NO	NO	11.45	17.52	10.08	23.43	23.62	19.76	13.27	20.39	35.04	5.12	14.00
859F	EVO 2	Fiberglass	FIA	CS.831.97	L	NO	NO	11.45	18.03	10.63	23.66	23.62	20.91	14.57	19.88	34.45	5.91	20.00
860F	PRO WRC	Fiberglass	FIA	CS.984.99	M	NO	NO	11.45	16.85	9.45	23.31	23.23	20.20	12.76	20.08	34.84	4.33	17.50
860Z	PRO WRC	Carbon	FIA	CS.949.99	M	NO	NO	11.45	16.85	9.45	23.31	23.23	20.20	12.76	20.08	34.84	4.33	14.50
864F	REV	Fiberglass	FIA	CS.915.98	S+M	NO	NO	11.45	17.60	11.42	22.80	21.85	19.25	12.80	19.49	34.06	4.72	18.00
865F	REV PLUS	Fiberglass	FIA	TBA	M	NO	NO	11.45	18.70	13.00	24.00	22.00	20.00	13.25	20.00	34.20	5.00	21.00
887F	CORSA	Fiberglass	FIA	CS.937.98	M	NO	NO	11.45	18.11	9.13	23.62	23.62	19.25	13.19	21.85	35.98	1.38	22.00
887Z	CORSA	Carbon	FIA	CS.952.99	M	NO	NO	11.45	18.11	9.13	23.62	23.62	19.25	13.19	21.85	35.98	1.38	14.00
892F	CIRCUIT	Fiberglass	FIA	CS.083.03	M	NO	NO	11.45	17.52	10.83	23.03	22.64	18.11	12.80	22.05	36.61	3.35	25.00
892Z	CIRCUIT S-LIGHT	Carbon	FIA	CS.083.03	M	NO	NO	11.45	17.52	10.83	23.03	22.64	18.11	12.80	22.05	36.61	3.35	15.00
893Z	S-LIGHT	Carbon	FIA	CS.950.99	M	NO	NO	11.45	16.93	11.02	22.83	22.83	19.69	14.57	18.90	35.83	4.72	14.00
915	SPEED	Steel Tube	/	/	M	271 x 345	NO	17.48	13.19	20.94	21.85	18.86	14.96	21.06	34.25	4.96	17.00	
944A	MILANO	Steel Tube	TUV	/	M	271 x 345	NO	19.25	10.43	22.17	22.44	19.13	13.19	24.61	35.43	NA	44.00	
945	MONZA	Steel Tube	TUV	/	M	271 x 345	NO	20.08	11.14	22.36	22.64	19.61	12.20	24.69	36.22	NA	40.00	
946	TORINO	Steel Tube	TUV	/	M	271 x 345	NO	19.25	10.43	22.17	22.44	19.13	13.19	24.61	35.43	NA	40.00	
947P	MILANO PRESTIGE	Steel Tube	TUV	/	M	271 x 345	NO	19.25	10.43	22.17	22.44	19.13	13.19	24.61	35.43	NA	48.00	
948	SIENA	Steel Tube	/	/	M+L	271 x 345	NO	19.88	10.83	20.04	21.06	21.06	11.42	24.61	34.45	NA	30.00	
953	ROADSTER	Fiberglass	/	/	M	271 x 345	NO	18.66	9.84	22.52	23.43	19.25	12.76	20.67	34.57	1.38	16.00	
954	FIGHTER	Fiberglass	/	/	M+L	271 x 345	NO	18.54	11.61	23.98	23.62	20.08	14.57	19.88	35.08	4.13	20.00	

Shell Type:
F = Fiberglass, T = Tube Frame, C = Carbon

Body Size Fitment:
S = small, M = Medium, L = Large

Bottom Mount measurements in MM.
All other measurements in INCHES.

More than
1000 CUSTOM BASES
available for your Sparco seat.

There are more than 1000 vehicle specific bases available. Pictured below are the two different styles of mounts. The "Flat" version is designed to position the seat as low as possible in the vehicle, ideal for helmet clearance. The "Tabbed" version offers variable height selection. Both designs may not be available for every application. Please check with your dealer for details on which bases is suited for your needs.

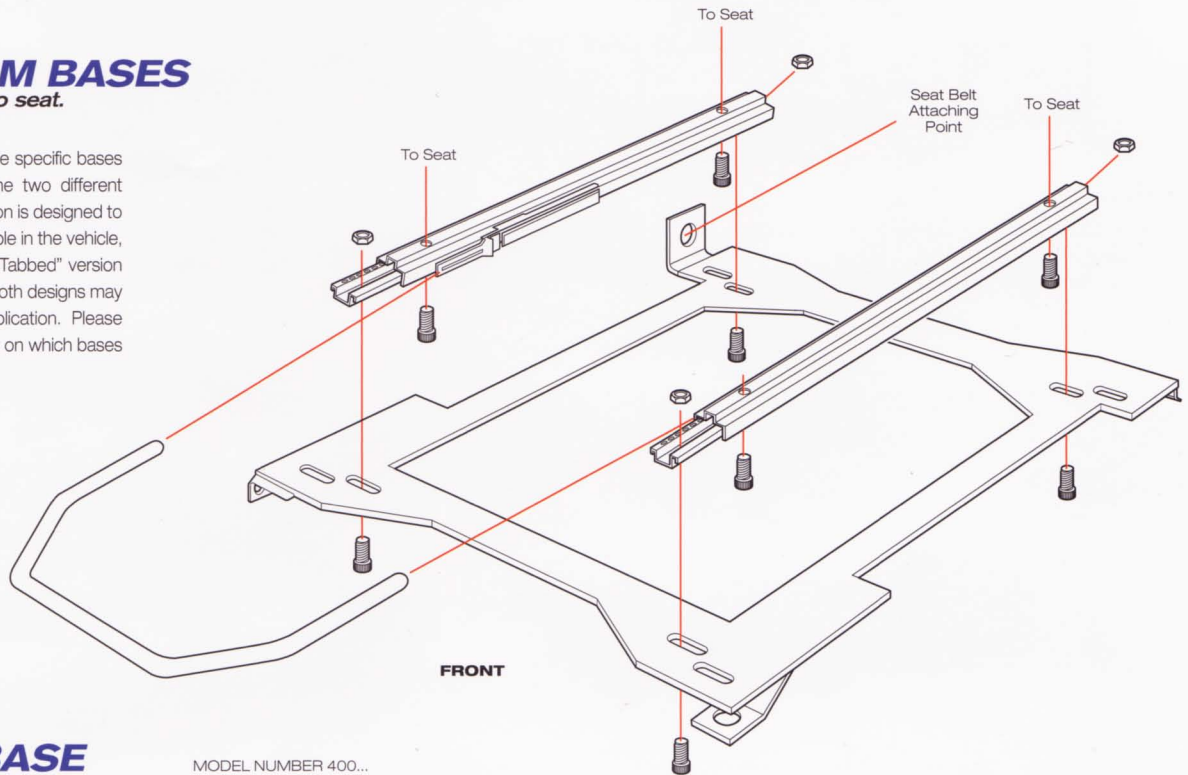

FLAT SEAT BASE

MODEL NUMBER 400...

Before attempting installation verify that you have all the correct and necessary part numbers for your application. In addition to your vehicle specific bases you will also need parts numbers 00493 (sliding tracks) and 50001 (hardware kit), one each will be needed per seat. We make seat bases for many applications however this does not guarantee that every model Sparco seat will fit in a particular vehicle. Please take the necessary measurements to ensure fitment prior to installation and ask your dealer for recommendations.

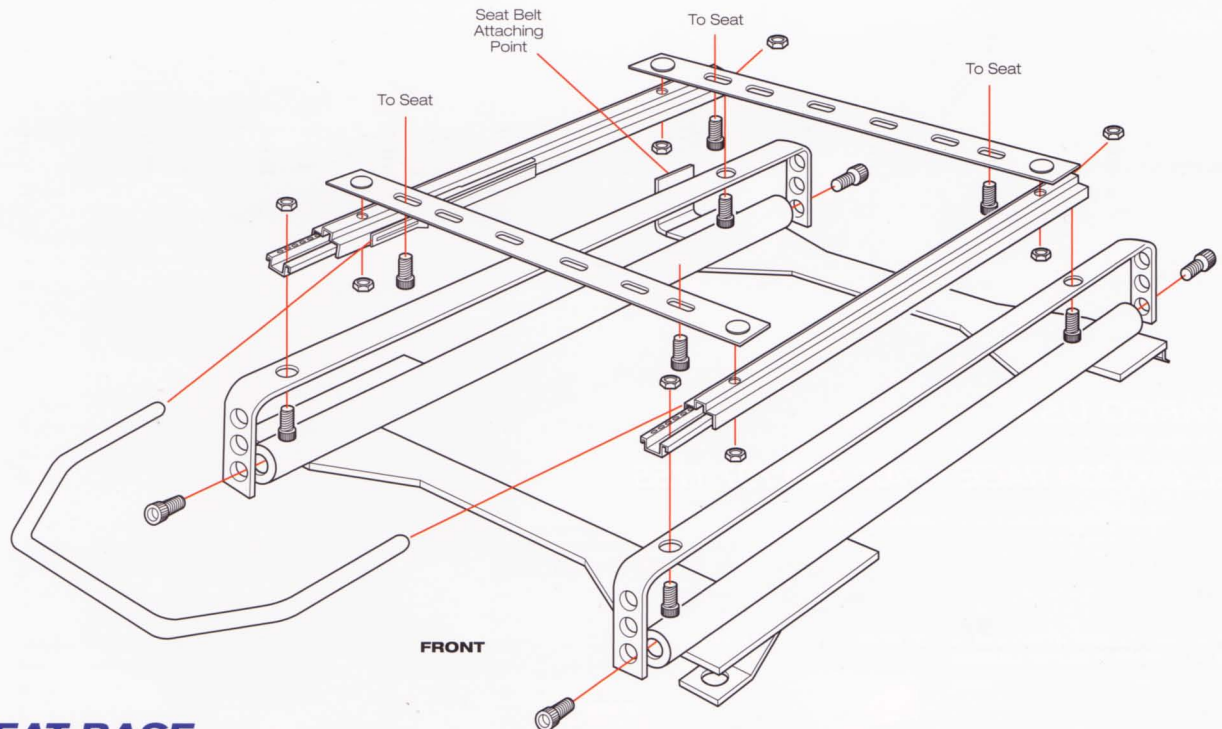

TABBED SEAT BASE

MODEL NUMBER 500...

Before attempting installation verify that you have all the correct and necessary part numbers for your application. In addition to your vehicle specific bases you will also need part numbers 00493 (sliding tracks), 500 (base adapter) and 50001 (hardware kit), one each will be needed per seat. We make seat bases for many applications however this does not guarantee that every model Sparco seat will fit in a particular vehicle. Please take the necessary measurements to ensure fitment prior to installation and ask your dealer for recommendations.

WWW.SPARCOUSA.COM

SPARCO USA

1852 Kaiser Ave, Irvine, CA 92614

TEL: 800.224.RACE • FAX: 949.797.1755

Motor sports are dangerous. No warranty or representation is made as to product's ability to protect the user from any injury or death. The user assumes that risk. Sparco Motor Sports' products are legal in all 50 states for use on racing vehicles which may never be used upon a highway. Not applicable or intended for street or highway use.

Contact your nearest Authorized Sparco Dealer
for a copy of these Sparco catalogs:



TUNING



KARTING



HELMET

Visit us online:



WWW.SPARCOUSA.COM